

# CABLING GUIDE

## FmX<sup>®</sup> Integrated Display

**Version 6.50**  
Revision B  
June 2013  
Part Number 71504-00-ENG



## Contact Information

Trimble Navigation Limited  
Trimble Agriculture Division  
10355 Westmoor Drive  
Suite #100  
Westminster, CO 80021  
USA

[trimble\\_support@trimble.com](mailto:trimble_support@trimble.com)

## Legal Notices

### Copyright and Trademarks

© 2009-2013, Trimble Navigation Limited. All rights reserved.

Trimble, the Globe and Triangle logo, AgGPS, EZ-Boom, EZ-Guide, EZ-Steer, FmX, and Tru Count Air Clutch are trademarks of Trimble Navigation Limited, registered in the United States and in other countries. Autopilot, Field-IQ, FieldManager, FM-1000, Rawson, TrueGuide, TrueTracker, and Tru Application Control are trademarks of Trimble Navigation Limited. GreenSeeker is a registered trademark of NTech Limited.

All other trademarks are the property of their respective owners.

This product is covered by the following United States Patent Numbers: 5,311,149, 5,369,589, 5,987,383, 6,252,863, 5,402,450, 5,493,588, and 6,463,374. Other patents pending.

## Release Notice

This is the June 2013 release (Revision B) of the *FmX Integrated Display Cabling Guide*. It applies to version 6.50 of the FmX integrated display firmware.

## LIMITED WARRANTY TERMS AND CONDITIONS

### Product Limited Warranty

Trimble Navigation Limited (“Trimble”) warrants that this product and its internal components (the “Product”) shall be free from defects in materials and workmanship and will substantially conform to Trimble’s applicable published specifications for the Product for a period of two (2) years, starting from the earlier of (i) the date of installation, or (ii) six (6) months from the date of original Product shipment from Trimble.

## Product Software

Product software, whether built into hardware circuitry as firmware, provided as a standalone computer software product, embedded in flash memory, or stored on magnetic or other media, is licensed solely for use with or as an integral part of the Product and is not sold. If accompanied by a separate end user license agreement (“EULA”), use of any such software will be subject to the terms of such end user license agreement (including any differing limited warranty terms, exclusions, and limitations), which shall control over the terms and conditions set forth in this limited warranty.

## Software Fixes

During the limited warranty period you will be entitled to receive such Fixes to the Product software that Trimble releases and makes commercially available and for which it does not charge separately, subject to the procedures for delivery to purchasers of Trimble products generally. If you have purchased the Product from an authorized Trimble dealer rather than from Trimble directly, Trimble may, at its option, forward the software Fix to the Trimble dealer for final distribution to you. Minor Updates, Major Upgrades, new products, or substantially new software releases, as identified by Trimble, are expressly excluded from this update process and limited warranty. Receipt of software Fixes or other enhancements shall not serve to extend the limited warranty period.

For purposes of this warranty the following definitions shall apply: (1) “Fix(es)” means an error correction or other update created to fix a previous software version that does not substantially conform to its Trimble specifications; (2) “Minor Update” occurs when enhancements are made to current features in a software program; and (3) “Major Upgrade” occurs when significant new features are added to software, or when a new product containing new features replaces the further development of a current product line. Trimble reserves the right to determine, in its sole discretion, what constitutes a Fix, Minor Update, or Major Upgrade.

## Warranty Remedies

If the Trimble Product fails during the warranty period for reasons covered by this limited warranty and you notify Trimble of such failure during the warranty period, Trimble will repair OR replace

or reconditioned parts or Product, OR refund the Product purchase price paid by you, at Trimble’s option, upon your return of the Product in accordance with Trimble’s product return procedures then in effect.

## How to Obtain Warranty Service

To obtain warranty service for the Product, please contact your local Trimble authorized dealer. Alternatively, you may contact Trimble to request warranty service at +1-408-481-6940 (24 hours a day) or e-mail your request to [trimble\\_support@trimble.com](mailto:trimble_support@trimble.com). Please be prepared to provide:

- your name, address, and telephone numbers
- proof of purchase
- a copy of this Trimble warranty
- a description of the nonconforming Product including the model number
- an explanation of the problem

The customer service representative may need additional information from you depending on the nature of the problem.

## Warranty Exclusions and Disclaimer

This Product limited warranty shall only apply in the event and to the extent that (a) the Product is properly and correctly installed, configured, interfaced, maintained, stored, and operated in accordance with Trimble’s applicable operator’s manual and specifications, and; (b) the Product is not modified or misused. This Product limited warranty shall not apply to, and Trimble shall not be responsible for, defects or performance problems resulting from (i) the combination or utilization of the Product with hardware or software products, information, data, systems, interfaces, or devices not made, supplied, or specified by Trimble; (ii) the operation of the Product under any specification other than, or in addition to, Trimble’s standard specifications for its products; (iii) the unauthorized installation, modification, or use of the Product; (iv) damage caused by: accident, lightning or other electrical discharge, fresh or salt water immersion or spray (outside of Product specifications); or exposure to environmental conditions for which the Product is not intended; (v) normal wear and tear on consumable parts (e.g., batteries); or (vi) cosmetic damage. Trimble does not warrant or guarantee the results obtained through the use of the Product, or that software components will operate error free.

**NOTICE REGARDING PRODUCTS EQUIPPED WITH TECHNOLOGY CAPABLE OF TRACKING SATELLITE SIGNALS FROM SATELLITE BASED AUGMENTATION SYSTEMS (SBAS) (WAAS/EGNOS, AND MSAS), OMNISTAR, GPS, MODERNIZED GPS OR GLONASS SATELLITES, OR FROM IALA BEACON SOURCES: TRIMBLE IS NOT RESPONSIBLE FOR THE OPERATION OR FAILURE OF OPERATION OF ANY SATELLITE BASED POSITIONING SYSTEM OR THE AVAILABILITY OF ANY SATELLITE BASED POSITIONING SIGNALS.**

THE FOREGOING LIMITED WARRANTY TERMS STATE TRIMBLE’S ENTIRE LIABILITY, AND YOUR EXCLUSIVE REMEDIES, RELATING TO THE TRIMBLE PRODUCT. EXCEPT AS OTHERWISE EXPRESSLY PROVIDED HEREIN, THE PRODUCT, AND ACCOMPANYING DOCUMENTATION AND MATERIALS ARE PROVIDED “AS-IS” AND WITHOUT EXPRESS OR IMPLIED WARRANTY OF ANY KIND, BY EITHER TRIMBLE OR ANYONE WHO HAS BEEN INVOLVED IN ITS CREATION, PRODUCTION, INSTALLATION, OR DISTRIBUTION, INCLUDING, BUT NOT LIMITED TO, THE IMPLIED WARRANTIES OF MERCHANTABILITY AND FITNESS FOR A PARTICULAR PURPOSE, TITLE, AND NON-INFRINGEMENT. THE STATED EXPRESS WARRANTIES ARE IN LIEU OF ALL OBLIGATIONS OR LIABILITIES ON THE PART OF TRIMBLE ARISING OUT OF, OR IN CONNECTION WITH, ANY PRODUCT. BECAUSE SOME STATES AND JURISDICTIONS DO NOT ALLOW LIMITATIONS ON DURATION OR THE EXCLUSION OF AN IMPLIED WARRANTY, THE ABOVE LIMITATION MAY NOT APPLY OR FULLY APPLY TO YOU.

## Limitation of Liability

TRIMBLE’S ENTIRE LIABILITY UNDER ANY PROVISION HEREIN SHALL BE LIMITED TO THE AMOUNT PAID BY YOU FOR THE PRODUCT. TO THE MAXIMUM EXTENT PERMITTED BY APPLICABLE LAW, IN NO EVENT SHALL TRIMBLE OR ITS SUPPLIERS BE LIABLE FOR ANY INDIRECT, SPECIAL, INCIDENTAL, OR CONSEQUENTIAL DAMAGE WHATSOEVER UNDER ANY CIRCUMSTANCE OR LEGAL THEORY RELATING IN ANYWAY TO THE PRODUCTS, SOFTWARE AND ACCOMPANYING DOCUMENTATION AND MATERIALS, (INCLUDING, WITHOUT LIMITATION, DAMAGES FOR LOSS OF BUSINESS PROFITS, BUSINESS INTERRUPTION, LOSS OF DATA, OR ANY OTHER PECUNIARY LOSS), REGARDLESS OF WHETHER TRIMBLE HAS BEEN ADVISED OF THE POSSIBILITY OF ANY SUCH LOSS AND REGARDLESS OF THE COURSE OF DEALING WHICH DEVELOPS OR HAS DEVELOPED BETWEEN YOU AND TRIMBLE. BECAUSE SOME STATES AND JURISDICTIONS DO NOT ALLOW THE EXCLUSION OR LIMITATION OF LIABILITY FOR CONSEQUENTIAL OR INCIDENTAL DAMAGES, THE ABOVE LIMITATION MAY NOT APPLY TO YOU.

**PLEASE NOTE: THE ABOVE TRIMBLE LIMITED WARRANTY PROVISIONS WILL NOT APPLY TO PRODUCTS PURCHASED IN THOSE JURISDICTIONS (E.G., MEMBER STATES OF THE EUROPEAN ECONOMIC AREA) IN WHICH PRODUCT WARRANTIES ARE THE RESPONSIBILITY OF THE LOCAL**

**TRIMBLE AUTHORIZED DEALER FROM WHOM THE PRODUCTS ARE ACQUIRED. IN SUCH A CASE, PLEASE CONTACT YOUR LOCAL TRIMBLE AUTHORIZED DEALER FOR APPLICABLE WARRANTY INFORMATION.**

Trimble Europe BV  
c/o Menlo Worldwide Logistics  
Meerheide 45  
5521 DZ Eersel, NL

### Official Language

THE OFFICIAL LANGUAGE OF THESE TERMS AND CONDITIONS IS ENGLISH. IN THE EVENT OF A CONFLICT BETWEEN ENGLISH AND OTHER LANGUAGE VERSIONS, THE ENGLISH LANGUAGE SHALL CONTROL.

### Registration

To receive information regarding updates and new products, please contact your local dealer or visit the Trimble website at [www.trimble.com/register](http://www.trimble.com/register). Upon registration you may select the newsletter, upgrade, or new product information you desire.

### Notices

#### Federal Communications Commission (FCC) Statement

Note: This equipment has been tested and found to comply with the limits for a Class A digital device, pursuant to Part 15 of the FCC Rules. These limits are designed to provide reasonable protection against harmful interference when the equipment is operated in a commercial environment. This equipment generates, uses, and can radiate radio frequency energy and, if not installed and used in accordance with the instruction manual, may cause harmful interference to radio communications. Operation of this equipment in a residential area is likely to cause harmful interference, in which case the user will be required to correct the interference at his own expense.

Properly shielded and grounded cables and connectors must be used in order to meet FCC emission limits. TRIMBLE is not responsible for any radio or television interference caused by using other than recommended cables and connectors or by unauthorized changes or modifications to this equipment. Unauthorized changes or modifications could void the user's authority to operate the equipment.

This device complies with Part 15 of the FCC rules. Operation is subject to the following two conditions: (1) this device may not cause harmful interference, and (2) this device must accept any interference received, including interference that may cause undesired operation.

Responsible Party:

Trimble Navigation  
935 Stewart Drive  
Sunnyvale CA 94085  
Telephone: 1-408 481 8000

#### Industry Canada Compliance Statement

This Class A digital apparatus meets the requirements of the Canadian Interference-Causing Equipment Regulations.

#### Avis de conformité à la réglementation d'Industrie Canada

Cet appareil numérique de la classe A respecte toutes les exigences du Règlement sur le matériel brouilleur du Canada.

#### European Community Compliance Statement

This product is in conformity with the protection requirements of EU Council Directive 89/336/EEC on the approximation of the laws of the Member States relating to electromagnetic compatibility. TRIMBLE cannot accept responsibility for any failure to satisfy the protection requirements resulting from a non-recommended modification of the product, including the fitting of non-TRIMBLE option cards.

#### Australia and New Zealand Class A Statement

Attention: This is a Class A product. In a domestic environment this product may cause radio interference in which case the user may be required to take adequate measures.

#### Notice to Our European Union Customers

For product recycling instructions and more information, please go to [www.trimble.com/ev.shtml](http://www.trimble.com/ev.shtml).

Recycling in Europe: To recycle Trimble WEEE (Waste Electrical and Electronic Equipment, products that run on electrical power.), Call +31 497 53 24 30, and ask for the "WEEE Associate". Or, mail a request for recycling instructions to:



#### Restriction of Use of Certain Hazardous Substances in Electrical and Electronic Equipment (RoHS)

This Trimble product complies in all material respects with DIRECTIVE 2002/95/EC OF THE EUROPEAN PARLIAMENT AND OF THE COUNCIL of 27 January 2003 on the restriction of the use of certain hazardous substances in electrical and electronic equipment (RoHS Directive) and Amendment 2005/618/EC filed under C(2005) 3143, with exemptions for lead in solder pursuant to Paragraph 7 of the Annex to the RoHS Directive applied.

#### Declaration of Conformity

We, Trimble Navigation Limited,

935 Stewart Drive  
PO Box 3642  
Sunnyvale, CA 94088-3642  
United States  
+1-408-481-8000

declare under sole responsibility that the product:  
FmX complies with Part 15  
of FCC Rules.

Operation is subject to the following two conditions:  
(1) this device may not cause harmful interference, and  
(2) this device must accept any interference received,

# Contents

<b>1</b>	<b>Cable Configuration Guidelines</b>	<b>7</b>
	Multiple cables on single ports	8
	Cable/port compatibility table	9
	Superseded cables	10
<b>2</b>	<b>Connecting the Display Only</b>	<b>11</b>
	Standalone FmX / WAAS / EGNOS / OmniSTAR XP/HP corrections	12
	Standalone FmX / RTK corrections	13
<b>3</b>	<b>Connecting to the EZ-Steer System</b>	<b>14</b>
	FmX / EZ-Steer / WAAS / EGNOS corrections using the power bus	15
	FmX / EZ-Steer / WAAS / EGNOS corrections with external power leads	16
<b>4</b>	<b>Connecting to the Autopilot System</b>	<b>17</b>
	FmX / Autopilot / WAAS/EGNOS corrections	18
	FmX / Autopilot / OmniSTAR XP/HP corrections	19
	FmX / Autopilot / RTK corrections	20
	FmX with external switch / Autopilot / RTK corrections	21
	FmX with ignition sensing / Autopilot / RTK corrections	22
	FmX / Autopilot / TrueGuide or Implement Monitoring	23
	FmX / Autopilot / TrueGuide or Implement Monitoring with an AgGPS 252/262 external receiver	25
	FmX / Autopilot / TrueTracker / RTK corrections	27
	FmX / Autopilot / AgGPS 252/262	29
	FmX / Factory-ready CNH vehicle	30
	FmX / Autopilot / Factory-ready CNH vehicle / external receiver	31
	FmX / Autopilot / AGCO Wheeled Tractors	32
<b>5</b>	<b>Connecting to the EZ-Pilot System</b>	<b>33</b>
	FmX / EZ-Pilot	34
<b>6</b>	<b>Connecting the Field-IQ Crop Input Control System</b>	<b>36</b>
	FmX / Field-IQ cab kit / Powell hitch connector	37
	FmX / Field-IQ cab kit / Powell hitch connector / power relay	38
	Field-IQ / Rawson Par 2 drives / Tru Count Air Clutch	39
	FmX / Field-IQ cab kit / Rawson PAR 40	40
	FmX / Autopilot / Field-IQ cab kit / Rawson PAR 40 / RTK Corrections	42
	FmX / Field-IQ Rate and Section control to Raven 4x0 or EZ-Boom harness	44
	FmX / Field-IQ Section Control only to the Raven 4x0	45
	FmX / Field-IQ Section Control to Raven 4x00	46
	FmX / Field-IQ Rate and Section Control to Raven 4x00	47
	FmX / Field-IQ Rate and Section Control for CaseIH SPX (2009 and later) sprayers	48
	FmX / Field-IQ Rate and Section Control to AGCO RoGator (2007 and later)	49
	FmX / Field-IQ cab kit / NH3 and liquid application full harness	50
	FmX / Autopilot / Field-IQ cab kit / Spreader	52
	FmX / Field-IQ Cab Kit / Seed Monitoring Only	53
	FmX / Field-IQ Cab Kit / Row Section Control	54

FmX / Field-IQ cab kit / Seed monitoring / Row section control . . . . .	56
FmX / Field-IQ cab kit / Seed monitoring / Rate and Section Control . . . . .	58
FmX / Field-IQ cab kit / Seed monitoring / Rate and Section Control/ Liquid Control . . . . .	60
FmX / Field-IQ Cab Kit / Seed Monitoring / Rawson PAR 2 Seeding . . . . .	63
FmX/Field-IQ Cab Kit / Seed Monitoring / Rawson PAR 2 Seeding / Row Section Control. . . . .	65
<b>7 Connecting to the GreenSeeker System . . . . .</b>	<b>67</b>
FmX / GreenSeeker . . . . .	68
<b>8 Connecting to the EZ-Boom System. . . . .</b>	<b>69</b>
Manual guidance FmX / EZ-Boom . . . . .	70
FmX / Autopilot / EZ-Boom / RTK corrections. . . . .	71
FmX / Autopilot / EZ-Boom / TrueTracker / RTK corrections . . . . .	72
FmX / EZ-Boom / EZ-Steer / RTK corrections / power bus . . . . .	74
FmX / EZ-Boom / EZ-Steer / RTK corrections / external power leads . . . . .	76
<b>9 Connecting to Radar Output and Serial Control . . . . .</b>	<b>78</b>
FmX / Autopilot / radar output / serial variable rate for Raven SCS400 or SCS600. . . . .	79
FmX / Autopilot / radar output / serial variable rate for Rawson . . . . .	81
FmX / Autopilot / radar output / serial variable rate . . . . .	83
FmX / Autopilot / serial connection for Hardi 5500 controller. . . . .	85
<b>10 Connecting to the Tru Application Control System . . . . .</b>	<b>86</b>
Manual guidance FmX / Tru Application Control . . . . .	87
FmX / Autopilot / Tru Application Control / RTK corrections. . . . .	88
FmX / Autopilot / Tru Application Control / TrueTracker / RTK corrections. . . . .	89
<b>11 Connecting External Receivers, Radios, and Modems. . . . .</b>	<b>91</b>
FmX / Autopilot / AgGPS 252/262 . . . . .	92
FmX / TrueGuide or Implement Monitoring with an AgGPS 252/262 external receiver . . . . .	93
FmX / Autopilot / External receiver for Implement Monitoring, TrueGuide, or FieldLevel II . . . . .	95
FmX / Autopilot / Ag3000 VRS corrections . . . . .	97
FmX / Autopilot / Sierra wireless modem . . . . .	98
FmX / Autopilot / DCM-300. . . . .	99
<b>12 Connecting the Yield Monitoring System. . . . .</b>	<b>101</b>
FmX / AgLeader YM2000 yield monitoring system . . . . .	102
FmX / John Deere 9x60 / 9x70 yield monitoring system . . . . .	103
FmX / Yield Monitoring system . . . . .	104
<b>13 Connecting the WM-Drain Solution. . . . .</b>	<b>105</b>
FmX / Water Management cabling. . . . .	106
FmX / WM-Drain / IMD-600 . . . . .	107
<b>14 Connecting to the FieldLevel II System . . . . .</b>	<b>109</b>
FmX / Autopilot / FieldLevel II / AGCO Challenger MT / RTK corrections . . . . .	110
FmX / Autopilot / FieldLevel II / CNH direct connect / RTK corrections . . . . .	112
FmX / Autopilot / FieldLevel II / John Deere direct-connect / RTK corrections . . . . .	114
FmX / Autopilot / FieldLevel II / Proportional valve / RTK corrections . . . . .	116
FmX / Autopilot / FieldLevel II / PT valve / RTK corrections . . . . .	118
FmX / FieldLevel II / Tandem or dual antenna / RTK corrections. . . . .	120
FmX / Autopilot / AgGPS 252/262 / FieldLevel II / Tandem or dual antenna / RTK corrections . . . . .	121
FmX / FieldLevel II / Without power bus. . . . .	123
<b>15 Connecting to an ISOBus System . . . . .</b>	<b>125</b>
FmX / ISOBus. . . . .	126

**16 Installing Accessories. . . . .128**

- FmX / 4 AgCam cameras / Autopilot / RTK corrections. . . . . 129
- FmX / Autopilot / EZ-Boom / Display-mounted LB25 external lightbar (option 1) . . . . . 130
- FmX / Autopilot / EZ-Boom / Remote-mounted LB25 external lightbar (option 2). . . . . 132
- FmX / Autopilot / EZ-Boom / multiple LB25 external lightbars / RTK corrections . . . . . 134
- FmX / EZ-Remote joystick. . . . . 136

# Cable Configuration Guidelines

## In this chapter:

- [Multiple cables on single ports](#)
- [Cable/port compatibility table](#)
- [Superseded cables](#)

This chapter includes guidelines on cabling options for the Trimble® FmX® integrated display.

## Multiple cables on single ports

Guidelines for configuring multiple cables on single ports.

- One communication type (that is, RS232 or CAN) can be used on each port. If two RS232 ports are required, the cabling should be configured to use port A and port B.



- The replicator port on most cables breaks away the pins not used by the primary device the cable was designed for. For example, if the RS232 port is required, the port replicator breaks out the CAN, digital pins, and so on. Do not connect the port replicator to the NavController II.

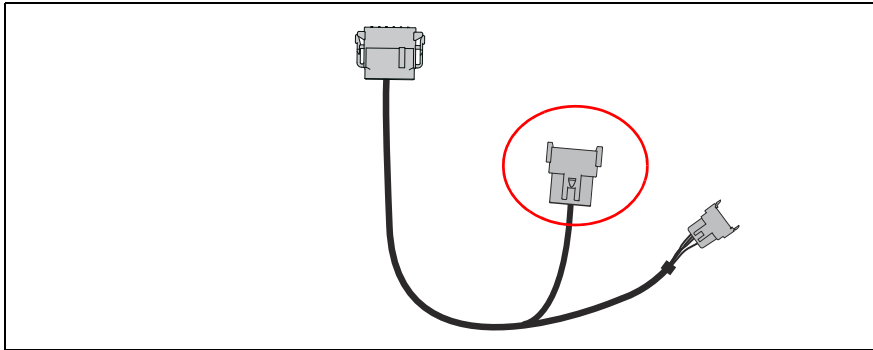

- Lightbars, the Field-IQ™ crop input control system, Tru Application Control™, the FieldLevel II system, the EZ-Steer® assisted steering system, yield monitoring and the EZ-Boom® automated application control system require their own dedicated CAN ports.
- The Autopilot™ automated steering system, the TrueTracker™ implement steering system, the EZ-Steer system, and radar output must be connected to port C or D.
- The Ag3000 modem can only be connected to port D.
- When using yield monitoring with CAN, only connect to port A.
- When using the LB25 lightbar and cable P/N 72420, you must use port B with internal termination.

## Cable/port compatibility table

Use this table to confirm which FmX integrated display cable can be used in each CAN port.



Function	Communication type	Dedicated CAN port required?	Port A ①	Port B ②	Port C ③	Port D ④
Autopilot	RS232				✓	✓
EZ-Steer	CAN	✓			✓	✓
TrueTracker	RS232				✓	✓
External 262 for True Guide	RS232		✓	✓		
External 332/442	RS232		✓	✓		
EZ-Boom®	CAN	✓	✓	✓		
Tru Application Control	CAN	✓	✓	✓		
Field-IQ	CAN	✓	✓	✓		
GreenSeeker	CAN	✓	✓	✓		
FieldLevel II	CAN	✓	✓	✓		
Yield monitoring	CAN	✓	✓			
Yield monitoring via serial	RS202		✓	✓	✓	✓
Serial VR	RS232		✓	✓		
Radar output	Digital				✓	✓
Remote output	Digital		✓	✓		
Cameras	Video		✓	✓	✓	✓
Lightbars	CAN	✓		✓		
Ag3000	RS232					✓
EZ-Remote	CAN	✓	✓	✓		

## Superseded cables

Cable updates since the previous FmX integrated display release are as follows:

Original part number	Cable	Replacement part number
65522	FmX to NavController II cable with port replicator	75741
67087	FmX to CAN cable with port replicator	75407

# Connecting the Display Only

## In this chapter:

- [Standalone FmX / WAAS / EGNOS / OmniSTAR XP/HP corrections](#)
- [Standalone FmX / RTK corrections](#)

The FmX integrated display can operate as a standalone guidance system, or you can connect it to a range of agricultural guidance devices to expand its functionality. This document shows you how to complete those cable connections.

## To connect the display:

- as a standalone guidance system, see [Chapter 2](#).
- to the EZ-Steer assisted steering system, see [Chapter 3](#)
- to the Autopilot automated steering system, see [Chapter 4](#).
- to a Field-IQ crop input control system, see [Chapter 6](#).
- to the GreenSeeker system, see [Chapter 7](#).
- to the EZ-Boom 2010 automated application control system, see [Chapter 8](#).
- for radar output or serial control, see [Chapter 9](#).
- to the Tru Application Control system, see [Chapter 10](#).
- to external receivers (including the Ag3000, see [Chapter 11](#)).
- to yield monitoring systems, see [Chapter 12](#).
- to the FieldLevel II system, see [Chapter 14](#).
- to additional accessories, see [Chapter 16](#).

## Standalone FmX / WAAS / EGNOS / OmniSTAR XP/HP corrections

This figure shows how to connect the FmX integrated display to use XP/HP corrections:

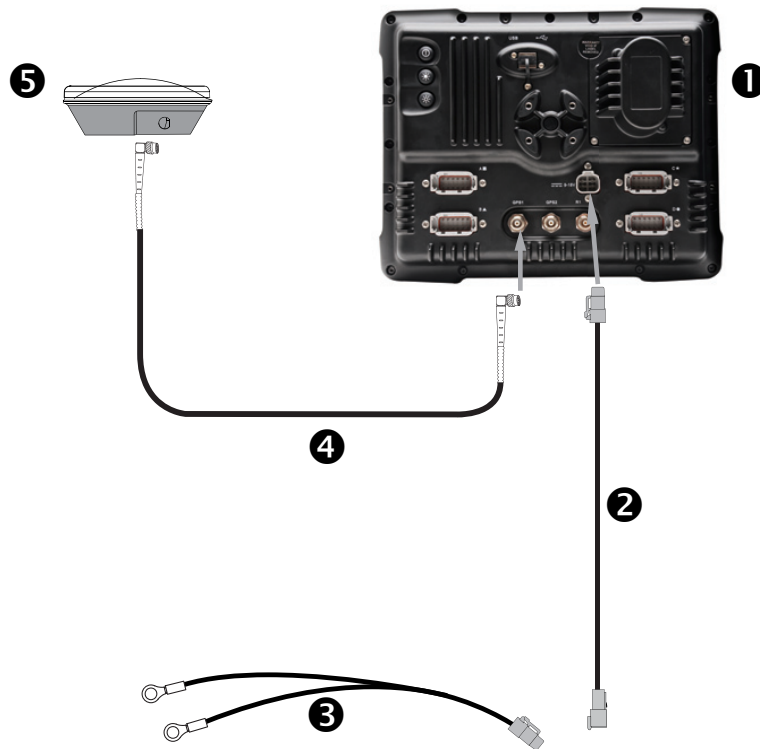

Item	Description	Trimble part number
❶	FmX integrated display	93100-01
❷	FmX power cable	66694
❸	FmX basic power cable	67258
❹	8 m GPS TNC/TNC RT angle cable	50449
❺	Ag25 GNSS antenna	77038-00

## Standalone FmX / RTK corrections

This figure shows how to connect a standalone FmX integrated display to use RTK corrections:

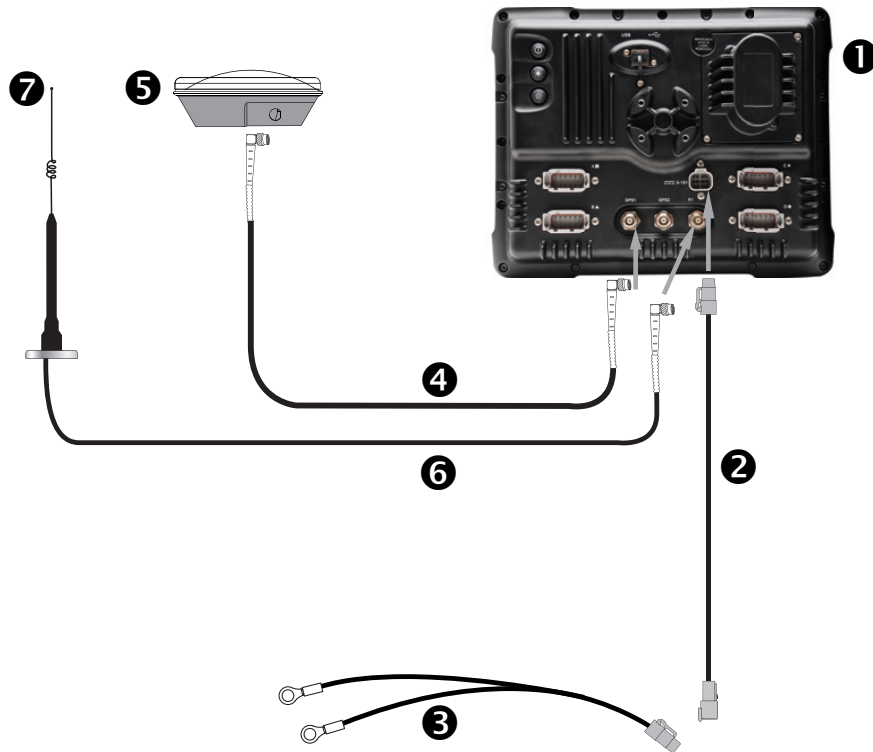

Item	Description	Trimble part number
1	FmX integrated display	93100-02
2	FmX power cable	66694
3	FmX basic power cable	67258
4	8 m GPS TNC/TNC RT angle cable	50449
5	Ag25 GNSS antenna	77038-00
6	NMO to TNC 20 ft antenna cable and base	62120
7	900 MHz radio antenna kit	22882-10

# Connecting to the EZ-Steer System

## In this chapter:

- FmX / EZ-Steer / WAAS / EGNOS corrections using the power bus
- FmX / EZ-Steer / WAAS / EGNOS corrections with external power leads

This chapter describes how to connect the FmX integrated display to the Trimble® EZ-Steer® assisted steering system.

## FmX / EZ-Steer / WAAS / EGNOS corrections using the power bus

This figure shows how to connect the FmX integrated display with the EZ-Steer assisted steering system, to use WAAS or EGNOS corrections:

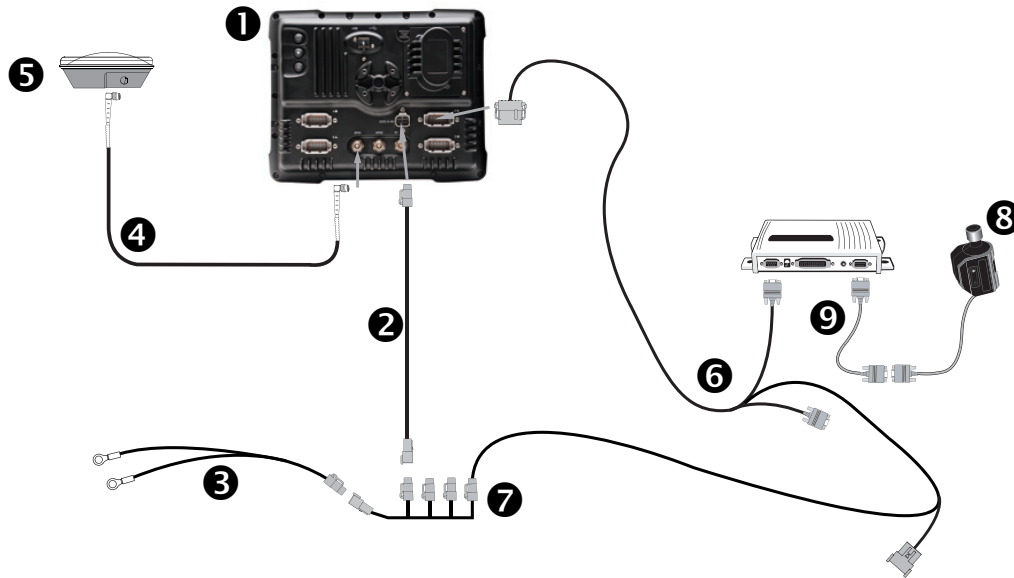

Item	Description	Trimble part number
1	FmX integrated display	93100-01
2	FmX power cable	66694
3	FmX basic power cable	67258
4	8 m GPS TNC/TNC RT angle cable	50449
5	Ag25 GNSS antenna	77038-00
6	FmX to EZ-Steer cable	75742
7	FmX power cable with relay and switch (power bus)	67259
8	EZ-Steer motor	53058-00
9	EZ-Steer motor cable	62257

**Note** – The EZ-Steer assisted steering system must be powered separately to power the motor.

**Note** – To use the EZ-Guide 500 lightbar cable (P/N 62974) and instructions on how to repin the cable, see the support bulletin *FmX - Modifying EZ-Steer Cable P/N 62974 For Use With FmX*.

## FmX / EZ-Steer / WAAS / EGNOS corrections with external power leads

This figure shows an alternative method for connecting the FmX integrated display with the EZ-Steer assisted steering system, to use WAAS or EGNOS corrections:

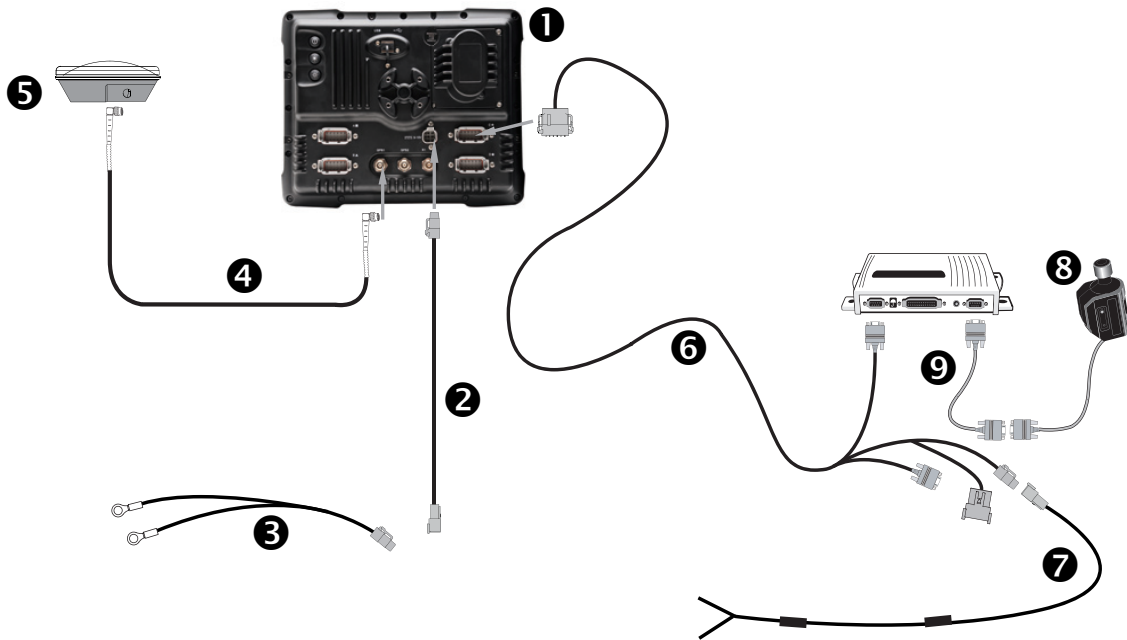

Item	Description	Trimble part number
❶	FmX integrated display	93100-01
❷	FmX power cable	66694
❸	FmX basic power cable	67258
❹	8 m GPS TNC/TNC RT angle cable	50449
❺	Ag25 GNSS antenna	77038-00
❻	FmX to EZ-Steer cable	75742
❼	Unterminated power cable	75743
❽	EZ-Steer motor	53058-00
❾	EZ-Steer motor cable	62257

**Note** – The EZ-Steer assisted steering system must be powered separately to power the motor.

**Note** – To use the EZ-Guide 500 lightbar cable (P/N 62974) and instructions on how to re-pin the cable, see the support bulletin *FmX - Modifying EZ-Steer Cable P/N 62974 For Use With FmX*

# Connecting to the Autopilot System

## In this chapter:

- FmX / Autopilot / WAAS/EGNOS corrections
- FmX / Autopilot / OmniSTAR XP/HP corrections
- FmX / Autopilot / RTK corrections
- FmX with external switch / Autopilot / RTK corrections
- FmX with ignition sensing / Autopilot / RTK corrections
- FmX / Autopilot / TrueGuide or Implement Monitoring
- FmX / Autopilot / TrueGuide or Implement Monitoring with an AgGPS 252/262 external receiver
- FmX / Autopilot / TrueTracker / RTK corrections
- FmX / Autopilot / AgGPS 252/262
- FmX / Factory-ready CNH vehicle
- FmX / Autopilot / Factory-ready CNH vehicle / external receiver
- FmX / Autopilot / AGCO Wheeled Tractors

This chapter shows the different ways to connect the FmX integrated display to the Autopilot™ automated steering system.



---

**CAUTION** – Connecting the Port Replicator on the FmX display to the NavController II cable to the P4 or P12 connector of the NavController II harness will result in damage to the FmX / FM-1000 integrated display, and will void the warranty.

---

## FmX / Autopilot / WAAS/EGNOS corrections

This figure shows how to connect the FmX integrated display with the Autopilot system to use the internal receiver:

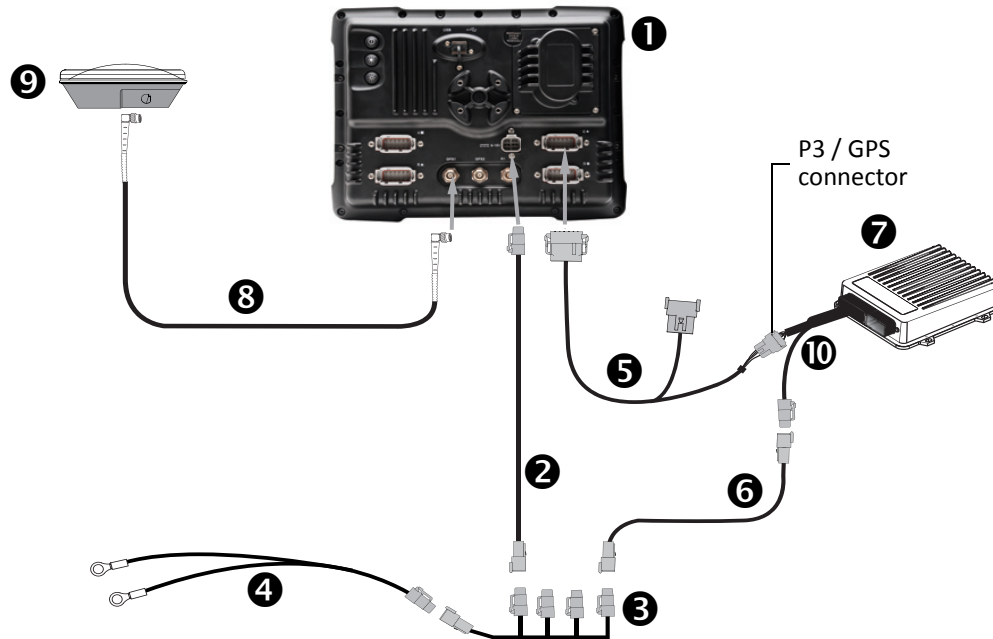

**CAUTION** – Connecting the Port Replicator on the FmX to NavController II cable ⑤ to the P4 or P12 connector of the NavController II harness ⑩ will result in damage to the FmX/FM-1000™ integrated display, and will void the warranty.

Item	Description	Trimble part number
①	FmX integrated display	93100-01
②	FmX power cable	66694
③	FmX power cable with relay and switch (power bus)	67259
④	Basic power cable	67258
⑤	FmX to NavController II cable with port replicator	75741
⑥	2 pin DTM to 2 pin DT power adaptor	67095
⑦	NavController II	55563-00
⑧	8m GPS TNC/TNC RT angle cable	50449
⑨	Ag25 GNSS antenna	77038-00
⑩	Main NavController II cable	54601

## FmX / Autopilot / OmniSTAR XP/HP corrections

This figure shows how to connect the FmX integrated display with the Autopilot system, to use OmniSTAR XP/HP corrections:

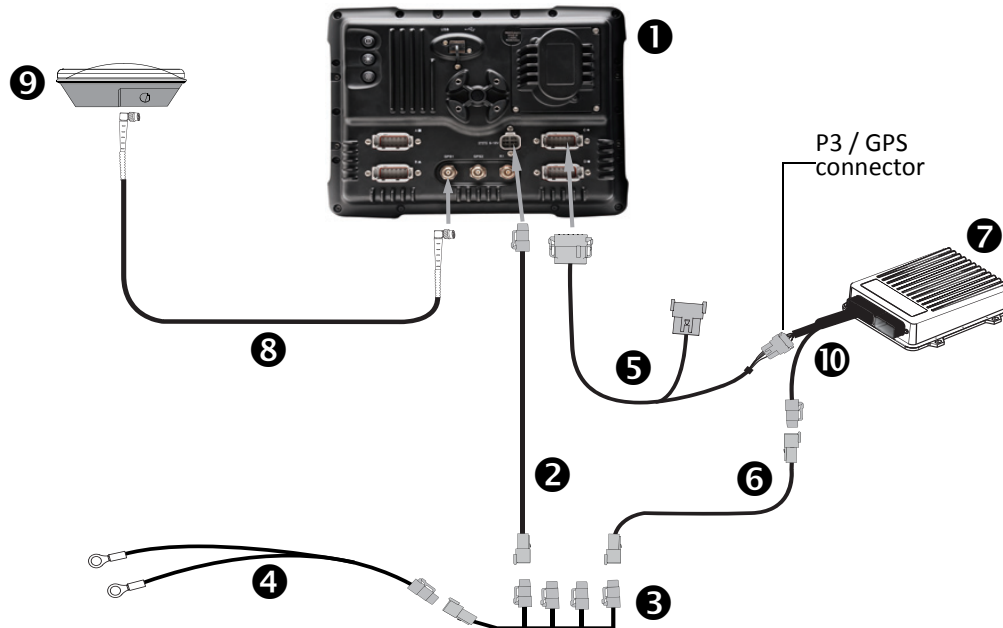

**CAUTION** – Connecting the Port Replicator on the FmX to NavController II cable ⑤ to the P4 or P12 connector of the NavController II harness ⑩ will result in damage to the FmX/FM-1000 integrated display, and will void the warranty.

Item	Description	Trimble part number
①	FmX integrated display	93100-01
②	FmX power cable	66694
③	FmX power cable with relay and switch (power bus)	67259
④	Basic power cable	67258
⑤	FmX to NavController II cable with port replicator	75741
⑥	2 pin DTM to 2 pin DT power adaptor	67095
⑦	NavController II	55563-00
⑧	8 m GPS TNC/TNC RT angle cable	50449
⑨	Ag25 GNSS antenna	77038-00
⑩	Main NavController II cable	54601

## FmX / Autopilot / RTK corrections

This figure shows how to connect the FmX integrated display with the Autopilot system to use RTK corrections:

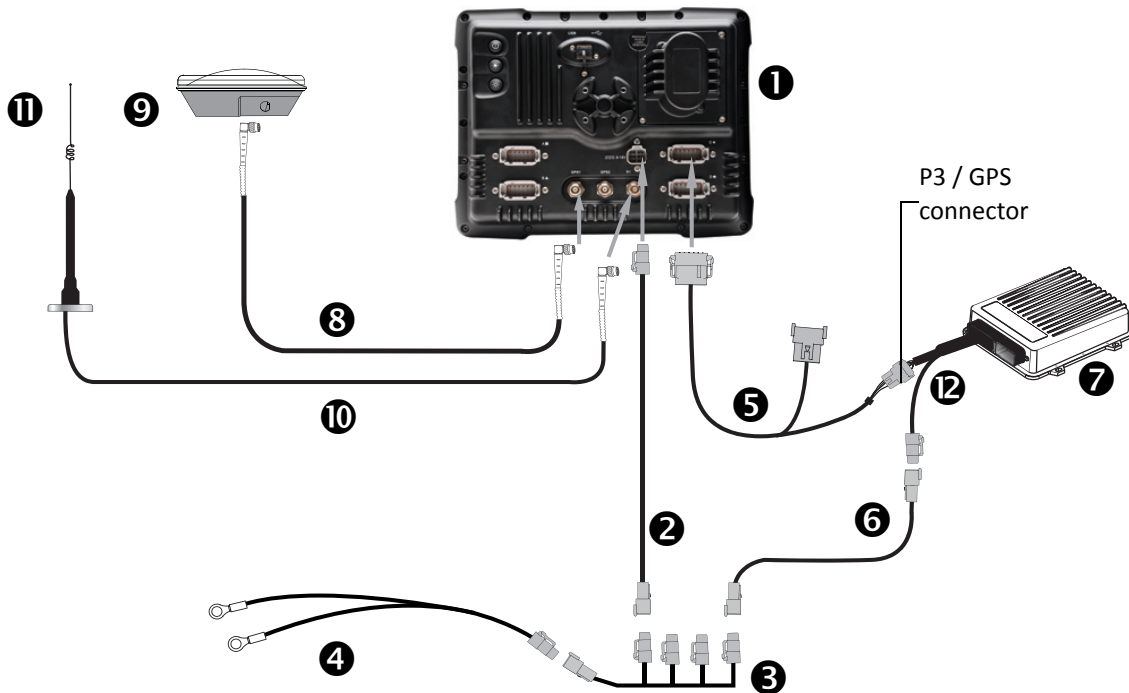

**CAUTION** – Connecting the Port Replicator on the FmX to NavController II cable ⑤ to the P4 or P12 connector of the NavController II harness ⑫ will result in damage to the FmX/FM-1000 integrated display, and will void the warranty.

Item	Description	Trimble part number
①	FmX integrated display	93100-02
②	FmX power cable	66694
③	FmX power cable with relay and switch (power bus)	67259
④	Basic power cable	67258
⑤	FmX to NavController II cable with port replicator	75741
⑥	2 pin DTM to 2 pin DT power adaptor	67095
⑦	NavController II	55563-00
⑧	8 m GPS TNC/TNC RT angle cable	50449
⑨	Ag25 GNSS antenna	77038-00
⑩	NMO to TNC 20 ft antenna cable and base	62120
⑪	900 MHz radio antenna kit	22882-10
⑫	Main NavController II cable	54601

## FmX with external switch / Autopilot / RTK corrections

This figure shows how to connect the FmX integrated display with the Autopilot system (controlled by an external switch) to use RTK corrections:

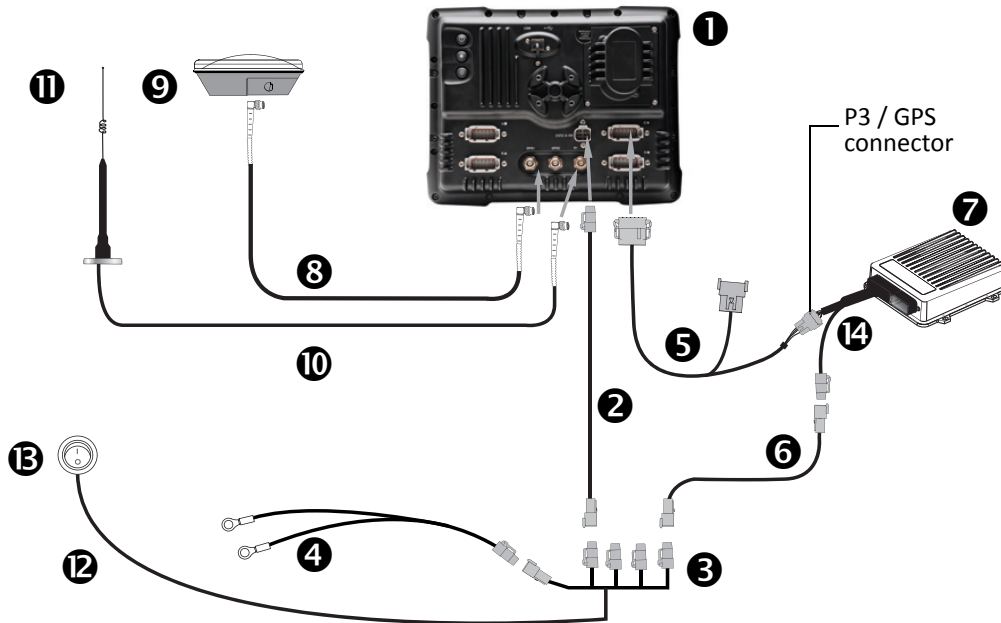

**CAUTION** – Connecting the Port Replicator on the FmX to NavController II cable 5 to the P4 or P12 connector of the NavController II harness 14 will result in damage to the FmX/FM-1000 integrated display, and will void the warranty.

Item	Description	Trimble part number
1	FmX integrated display	93100-02
2	FmX power cable	66694
3	FmX power cable with relay and switch (power bus)	67259
4	Basic power cable	67258
5	FmX to NavController II cable with port replicator	75741
6	2 pin DTM to 2 pin DT power adaptor	67095
7	NavController II	55563-00
8	8 m GPS TNC/TNC RT angle cable	50449
9	Ag25 GNSS antenna	77038-00
10	NMO to TNC 20 ft antenna cable and base	62120
11	900 MHz radio antenna kit	22882-10
12	External switch cable included with kit	Part of P/N 67259
13	External switch included with kit	Part of P/N 67259
14	Main NavController II cable	54601

## FmX with ignition sensing / Autopilot / RTK corrections

This figure shows how to connect the FmX integrated display with the Autopilot system (with ignition sensing) to use RTK corrections:

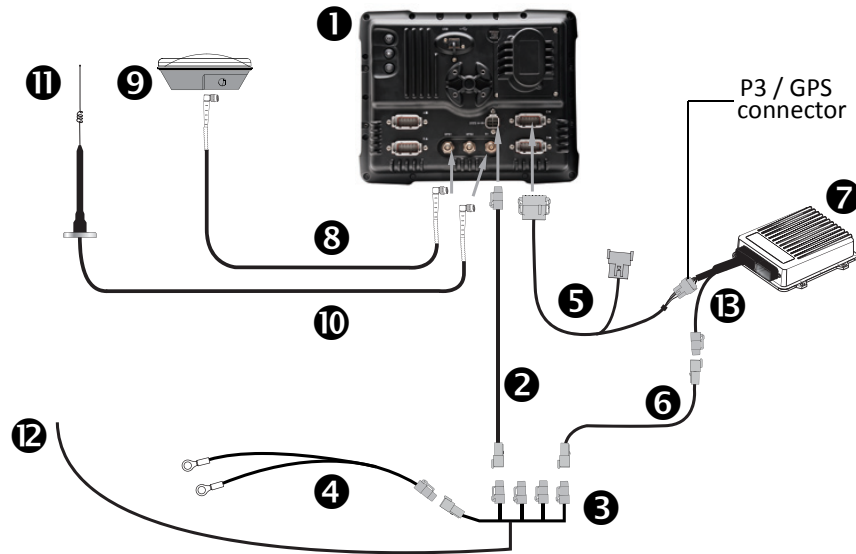

**CAUTION** – Connecting the Port Replicator on the FmX to NavController II cable **5** to the P4 or P12 connector of the NavController II harness **13** will result in damage to the FmX/FM-1000 integrated display, and will void the warranty.

Item	Description	Trimble part number
1	FmX integrated display	93100-02
2	FmX power cable	66694
3	FmX power cable with relay and switch (power bus)	67259
4	Basic power cable	67258
5	FmX to NavController II cable with port replicator	75741
6	2 pin DTM to 2 pin DT power adaptor	67095
7	NavController II	55563-00
8	8 m GPS TNC/TNC RT angle cable	50449
9	Ag25 GNSS antenna	77038-00
10	NMO to TNC 20ft antenna cable and base	62120
11	900 MHz radio antenna kit	22882-10
12	Ignition sense cable included with kit	Part of P/N 67259
13	Main NavController II cable	54601

## FmX / Autopilot / TrueGuide or Implement Monitoring

This figure shows how to connect the FmX integrated display with the Autopilot system, Trimble® TrueGuide™ implement guidance system, or implement monitoring to use RTK corrections:

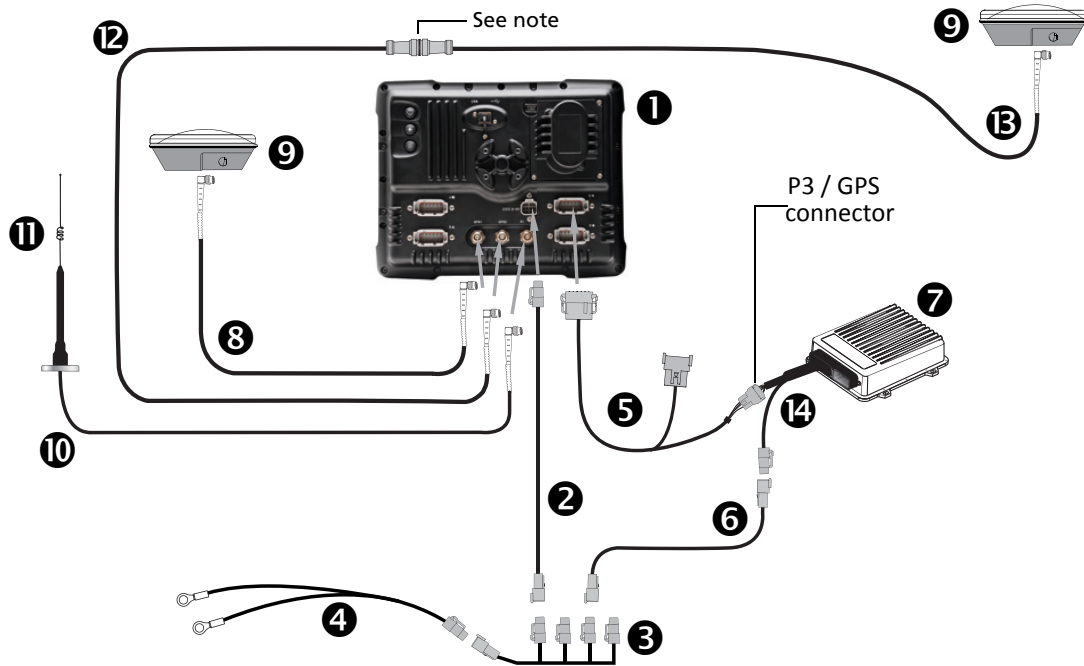

**CAUTION** – Connecting the Port Replicator on the FmX to NavController II cable 5 to the P4 or P12 connector of the NavController II harness 14 will result in damage to the FmX/FM-1000 integrated display, and will void the warranty.

**Note** – An optional LMR400 65' extension cable (P/N 67473) is available for implements with a long tongue.

Item	Description	Trimble part number
1	FmX integrated display	93100-02
2	FmX power cable	66694
3	FmX power cable with relay and switch (power bus)	67259
4	Basic power cable	67258
5	FmX to NavController II cable with port replicator	75741
6	2 pin DTM to 2 pin DT power adaptor	67095
7	NavController II	55563-00
8	8 m GPS TNC/TNC RT angle cable	50449
9	Ag25 GNSS antenna	77038-00
10	NMO to TNC 20 ft antenna cable and base	62120
11	900 MHz radio antenna kit	22882-10

Item	Description	Trimble part number
②	Coaxial 160" N/f + TNC/m-ra cable	68295
③	Coaxial 480" N/m + TNC/m-ra cable	67472
④	Main NavController II cable	54601

## FmX / Autopilot / TrueGuide or Implement Monitoring with an AgGPS 252/262 external receiver

This figure shows how to connect the FmX integrated display with the Autopilot system and the TrueGuide implement guidance system or implement monitoring, while using a second external AgGPS receiver:

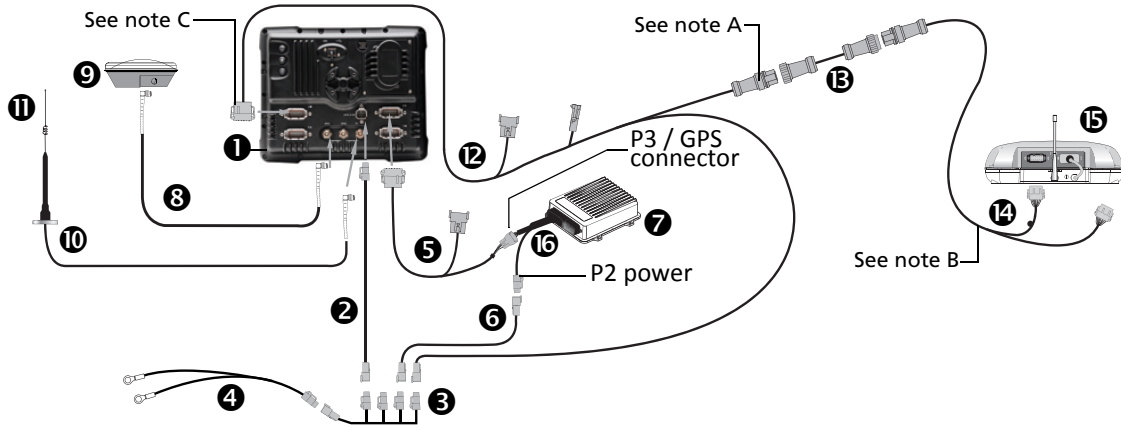

**CAUTION** – Connecting the Port Replicator on the FmX to NavController II cable **5** to the P4 or P12 connector of the NavController II harness **14** will result in damage to the FmX/FM-1000 integrated display, and will void the warranty.

**Note** – An optional 45' 10-pin data extension cable (P/N AG\_0793-1290-450) is available for implements with a long tongue.

**Note** – Connect to port "A" of the 252/262 receiver only.

**Note** – Connect to port "A" or "B".

Item	Description	Trimble part number
1	FmX integrated display	93100-02
2	FmX power cable	66694
3	FmX power cable with relay and switch (power bus)	67259
4	Basic power cable	67258
5	FmX to NavController II cable with port replicator	75741
6	2 pin DTM to 2 pin DT power adaptor	67095
7	NavController II	55563-00
8	8 m GPS TNC/TNC RT angle cable	50449
9	Ag25 GNSS antenna	77038-00
10	NMO to TNC 20 ft antenna cable and base	62120
11	900 MHz radio antenna kit	22882-10
12	FmX to TrueTracker cable	67092
13	Implement 10-pin data cable	0793-8740-450

Item	Description	Trimble part number
⑫	Cable assembly, implement receiver extension	75447
⑬	AgGPS 252/262 receiver	55500-xx
⑭	Main NavController II cable	54601
⑰	Sonalert	43104

## FmX / Autopilot / TrueTracker / RTK corrections

This figure shows how to connect the FmX integrated display with the Autopilot system and Trimble® TrueTracker™ implement steering system, to use RTK corrections:

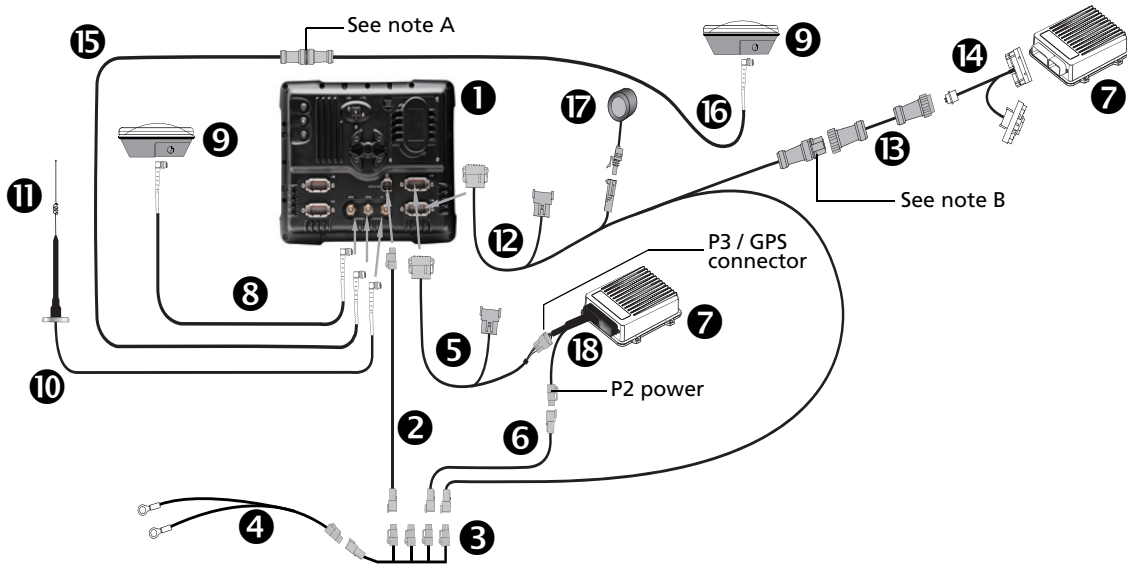

**CAUTION** – Connecting the Port Replicator on the FmX to NavController II cable ⑫ to the P4 or P12 connector of the NavController II harness ⑬ will result in damage to the FmX/FM-1000 integrated display, and will void the warranty.

**Note** – An optional LMR400 65' extension cable (P/N 67473) is available for implements with a long tongue.

**Note** – An optional 45' 10-pin data extension cable (P/N AG\_0793-1290-450) is available for implements with a long tongue

Item	Description	Trimble part number
①	FmX integrated display	93100-02
②	FmX power cable	66694
③	FmX power cable with relay and switch (power bus)	67259
④	Basic power cable	67258
⑤	FmX to NavController II cable with port replicator	75741
⑥	2 pin DTM to 2 pin DT power adaptor	67095
⑦	NavController II (x2)	55563-00
⑧	8 m GPS TNC/TNC RT angle cable	50449
⑨	Ag25 GNSS antenna (x2)	77038-00
⑩	NMO to TNC 20 ft antenna cable and base	62120
⑪	900 MHz radio antenna kit	22882-10
⑫	FmX to TrueTracker cable	67092
⑬	Implement extension cable	0793-8740-450

Item	Description	Trimble part number
⑭	FmX to NavController II and TrueTracker main harness	67612
⑮	Coaxial 160" N/f + TNC/m-ra cable	68295
⑯	Coaxial 480" N/m + TNC/m-ra cable	67472
⑰	Sonalert	43104
⑱	Main NavController II cable	54601

## FmX / Autopilot / AgGPS 252/262

This figure shows how to connect the FmX integrated display with the Autopilot system, to use an AgGPS 252 or 262 receiver:

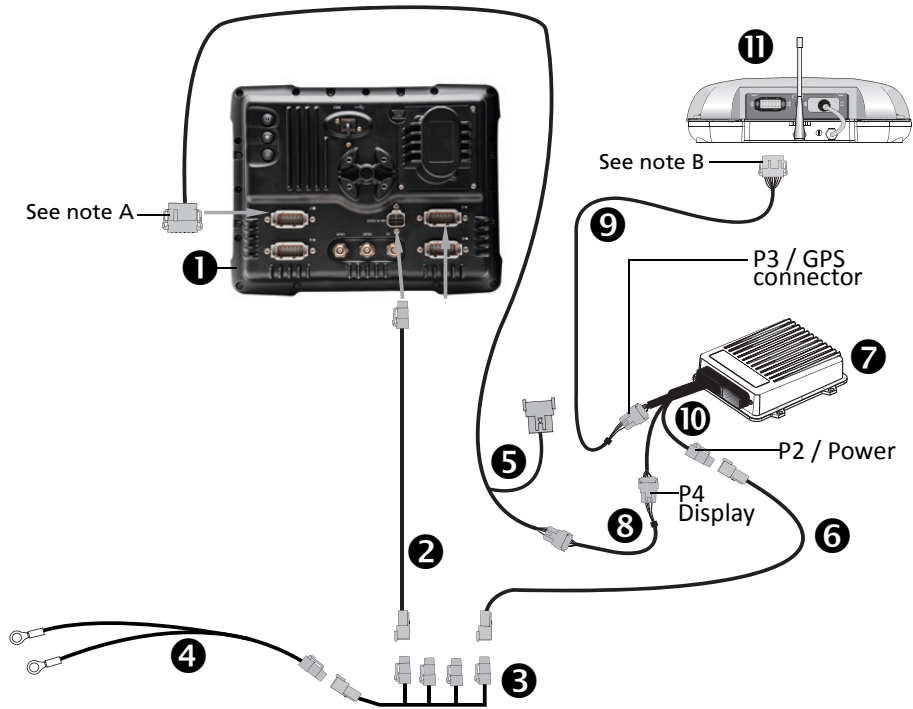

**CAUTION** – Connecting the Port Replicator on the FmX to NavController II cable 5 to the P4 or P12 connector of the NavController II harness 10 will result in damage to the FmX/FM-1000 integrated display, and will void the warranty.

**Note** – Connect only to port A or B on the FmX integrated display.

**Note** – Connect only to port A on the receiver.

Item	Description	Trimble part number
1	FmX integrated display	93100-01
2	FmX power cable	66694
3	FmX power cable with relay and switch (power bus)	67259
4	Basic power cable	67258
5	FmX to NavController II cable with port replicator	75741
6	2 pin DTM to 2 pin DT power adaptor	67095
7	NavController II	55563-00
8	Cable assembly, 8-pin to 12-pin adaptor	76442
9	Cable, AgGPS 252/262 to NavController II	54608
10	Main NavController II cable	54601
11	AgGPS 252/262 receiver	55500-xx

## FmX / Factory-ready CNH vehicle

This figure shows how to connect the FmX integrated display into a factory-ready CNH vehicle, to use RTK corrections:

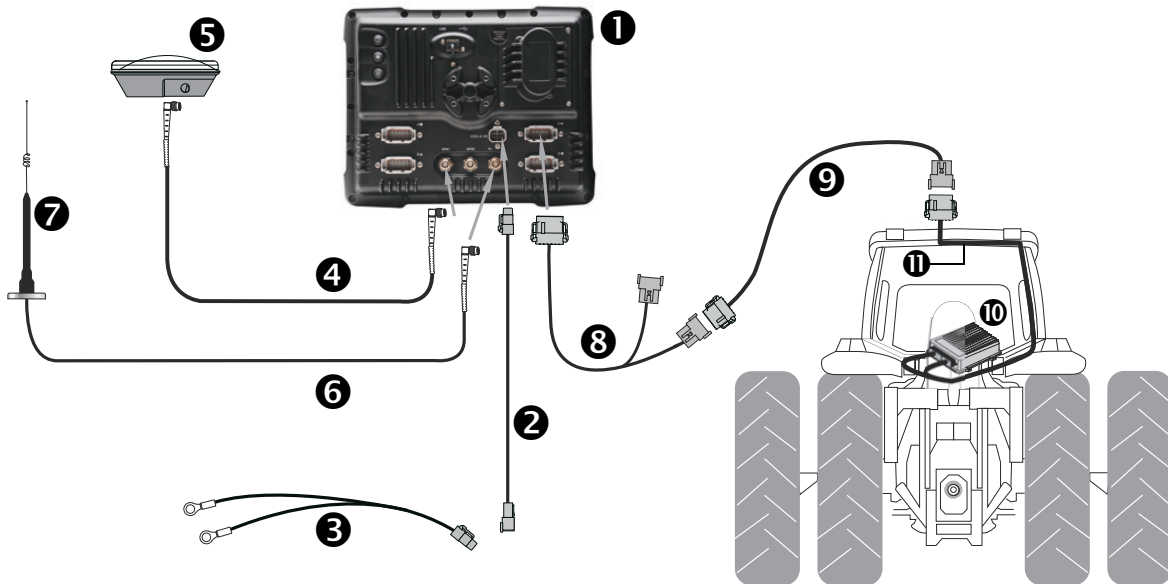

**CAUTION** – Connecting the Port Replicator on the FmX to NavController II cable **8** to the P4 connector of the NavController II harness will result in damage to the FmX/FM-1000 integrated display, and will void the warranty.

Item	Description	Trimble part number
1	FmX integrated display	93100-02
2	FmX power cable	66694
3	Basic power cable	67258
4	8 m GPS TNC/TNC RT angle cable	50449
5	Ag25 GNSS antenna	77038-00
6	NMO to TNC 20 ft antenna cable and base	62120
7	900 MHz radio antenna kit	22882-10
8	FmX to NavController II cable with port replicator	75741
9	CNH hybrid to GPS cable	67120
10	NavController II	55563-00
11	Factory-installed harness	N/A

## FmX / Autopilot / Factory-ready CNH vehicle / external receiver

This figure shows how to connect the FmX integrated display into a factory-ready CNH vehicle, using the Autopilot system and an AgGPS 252/262 external receiver:

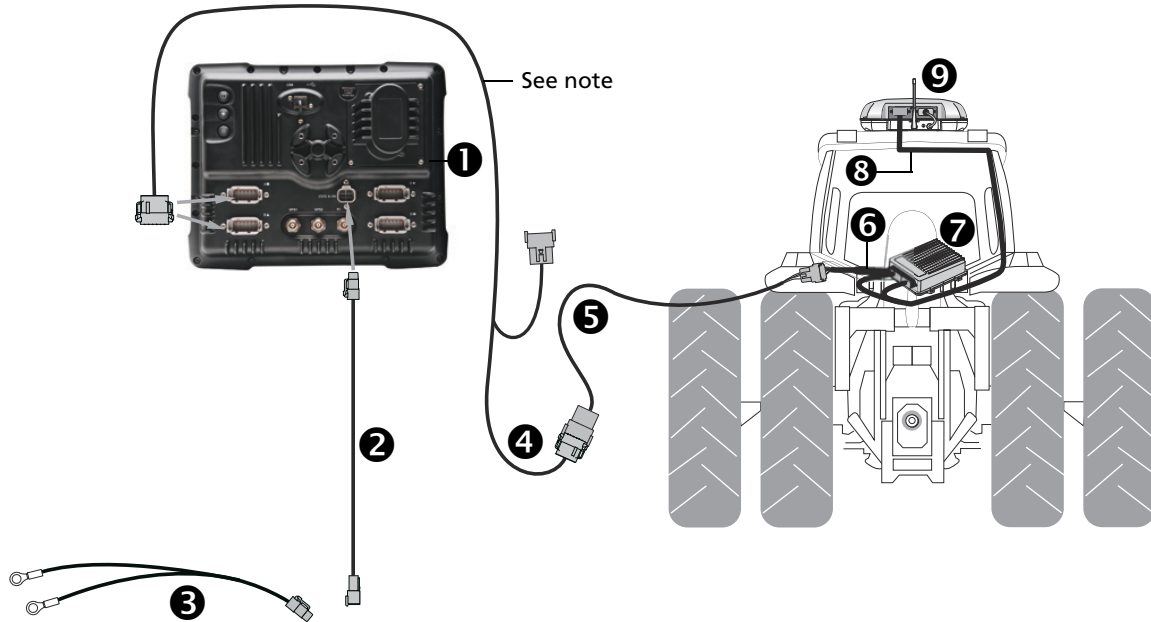

**CAUTION** – Connecting the Port Replicator on the FmX to NavController II cable ④ to the P4 connector of the NavController II harness will result in damage to the FmX/FM-1000 integrated display, and will void the warranty.

**Note** – Connect only to port A or B on the FmX integrated display.

Item	Description	Trimble part number
①	FmX integrated display	93100-02
②	FmX power cable	66694
③	Basic power cable	67258
④	FmX to NavController II cable with port replicator	75741
⑤	8-pin to 12-pin DTM adaptor cable	76442
⑥	CNH hybrid P4 extension cable kit	56694-00S
⑦	NavController II	55563-00
⑧	Factory installed harness	N/A
⑨	AgGPS 252/262 receiver	55500-xx

## FmX / Autopilot / AGCO Wheeled Tractors

This figure shows how to connect the FmX integrated display with the Autopilot system to a Challenger MT500/600, an AGCO DT or RT series, or a Massey Ferguson 8x00, 7x00 and 6x00 series vehicle:

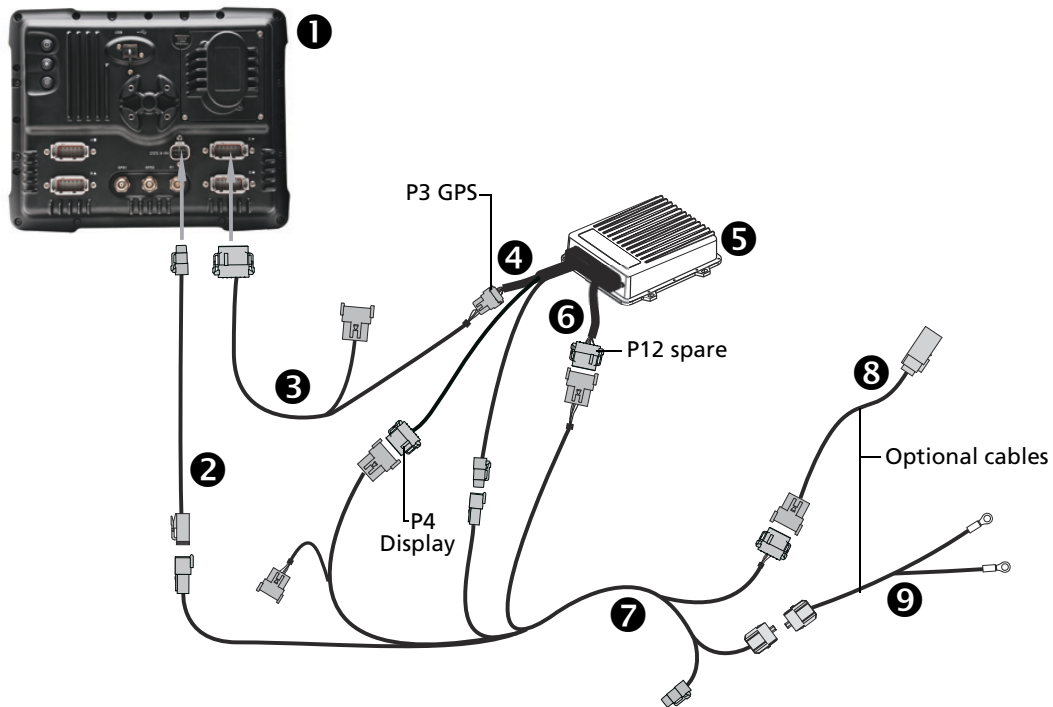

**CAUTION** – Connecting the Port Replicator on the FmX to NavController II cable ③ to the P4 or P12 connector of the NavController II harness ④ will result in damage to the FmX/FM-1000 integrated display, and will void the warranty.

Item	Description	Trimble part number
①	FmX integrated display	93100-01
②	FmX power cable	66694
③	FmX to NavController II cable with port replicator	75741
④	Main NavController II cable	54601
⑤	NavController II	55563-00
⑥	NavController II auxiliary cable	54602
⑦	Autopilot to AGCO power and CAN interface cable	77644 (incl w/ kit 77648)
⑧	Adaptor for early Autoguide models (optional)	77647 (incl w/ kit 77648)
⑨	Power adaptor for early Autoguide models (optional)	77646 (incl w/ kit 77648)

# Connecting to the EZ-Pilot System

## In this chapter:

- [FmX / EZ-Pilot](#)

This chapter shows how to connect the FmX integrated display to the EZ-Pilot™ steering system.

## FmX / EZ-Pilot

This figure shows how to connect the FmX integrated display to the EZ-Pilot system and a remote engage switch.

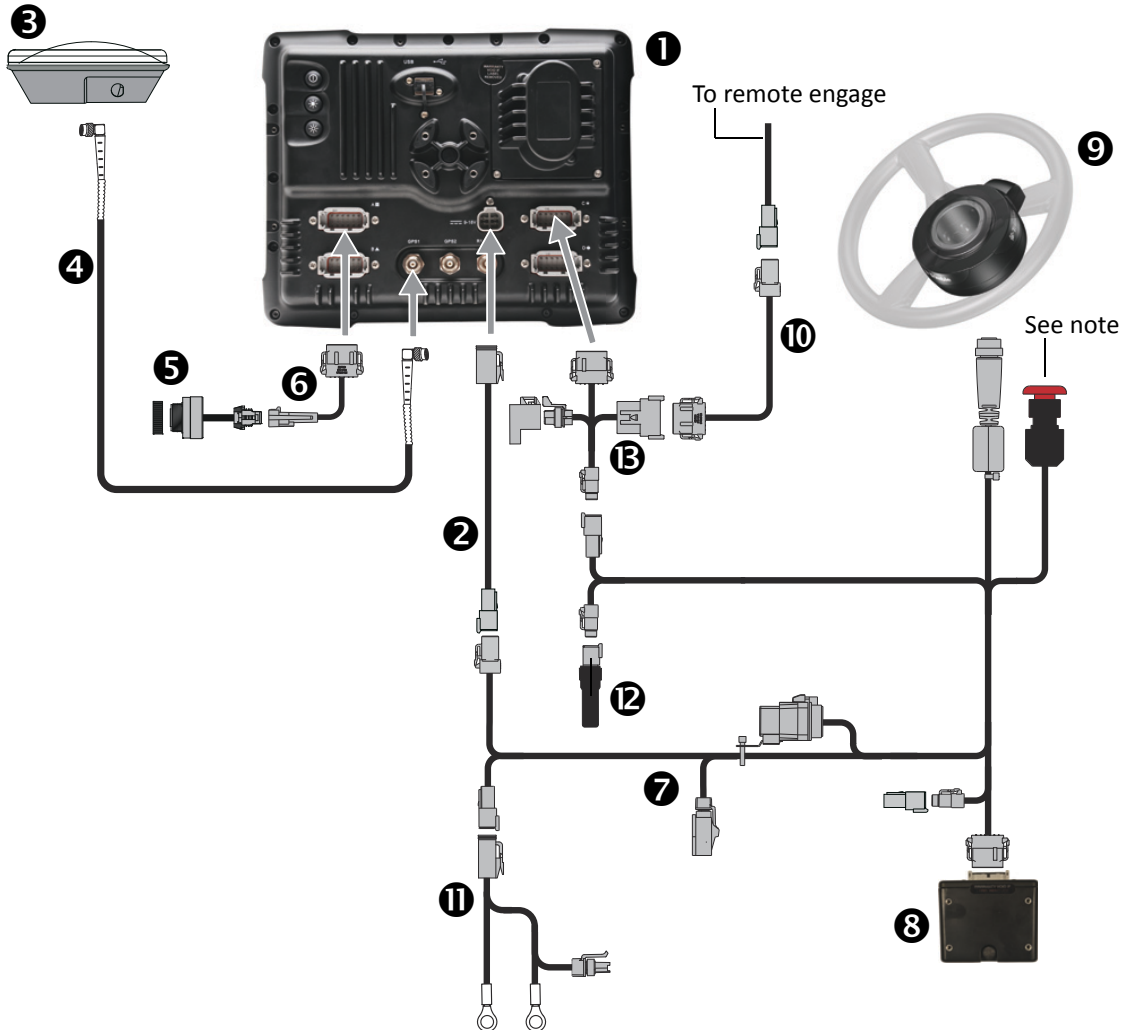

Item	Description	Trimble part number
1	FmX integrated display	93100-01
2	FmX power cable	66694
3	AG25 antenna	77038-00
4	8 M GPS TNC/TNC right angle cable	50449
5	Sonalert	43104
6	Display to Sonalert cable	84668
7	IMD-600 unit to SAM-200 motor to CAN and power cable <i>Note – The EZ-Pilot emergency stop button is part of this cable.</i>	76351
8	IMD-600 unit	83390-00
9	SAM-200 motor	83382-00
10	EZ-Pilot remote engage adapter cable	88506

Item	Description	Trimble part number
①	Base power cable	67259
②	CAN bus terminator	59783
③	Cable Assy, display to Field-IQ system	75834

# Connecting the Field-IQ Crop Input Control System

## In this chapter:

- FmX / Field-IQ cab kit / Powell hitch connector
- FmX / Field-IQ cab kit / Powell hitch connector / power relay
- Field-IQ / Rawson Par 2 drives / Tru Count Air Clutch
- FmX / Field-IQ cab kit / Rawson PAR 40
- FmX / Autopilot / Field-IQ cab kit / Rawson PAR 40 / RTK Corrections
- FmX / Field-IQ Rate and Section control to Raven 4x0 or EZ-Boom harness
- FmX / Field-IQ Section Control only to the Raven 4x0
- FmX / Field-IQ Section Control to Raven 4x00
- FmX / Field-IQ Rate and Section Control to Raven 4x00
- FmX / Field-IQ Rate and Section Control for CaseIH SPX (2009 and later) sprayers
- FmX / Field-IQ Rate and Section Control to AGCO RoGator (2007 and later)
- FmX / Field-IQ cab kit / NH3 and liquid application full harness
- FmX / Autopilot / Field-IQ cab kit / Spreader
- FmX / Field-IQ Cab Kit / Seed Monitoring Only
- FmX / Field-IQ Cab Kit / Row Section Control
- FmX / Field-IQ cab kit / Seed monitoring / Row section control
- FmX / Field-IQ cab kit / Seed monitoring / Rate and Section Control
- FmX / Field-IQ cab kit / Seed monitoring / Rate and Section Control/ Liquid Control
- FmX / Field-IQ Cab Kit / Seed Monitoring / Rawson PAR 2 Seeding
- FmX/Field-IQ Cab Kit / Seed Monitoring / Rawson PAR 2 Seeding / Row Section Control

This chapter shows the different ways to connect the FmX integrated display to the Field-IQ™ crop input control system.



**CAUTION** – Connecting the Port Replicator on the FmX display to the NavController II cable to the P4 or P12 connector of the NavController II harness will result in damage to the FmX / FM-1000 integrated display, and will void the warranty.

## FmX / Field-IQ cab kit / Powell hitch connector

Connecting the FmX integrated display with the Field-IQ cab kit, and a Powell hitch connector:

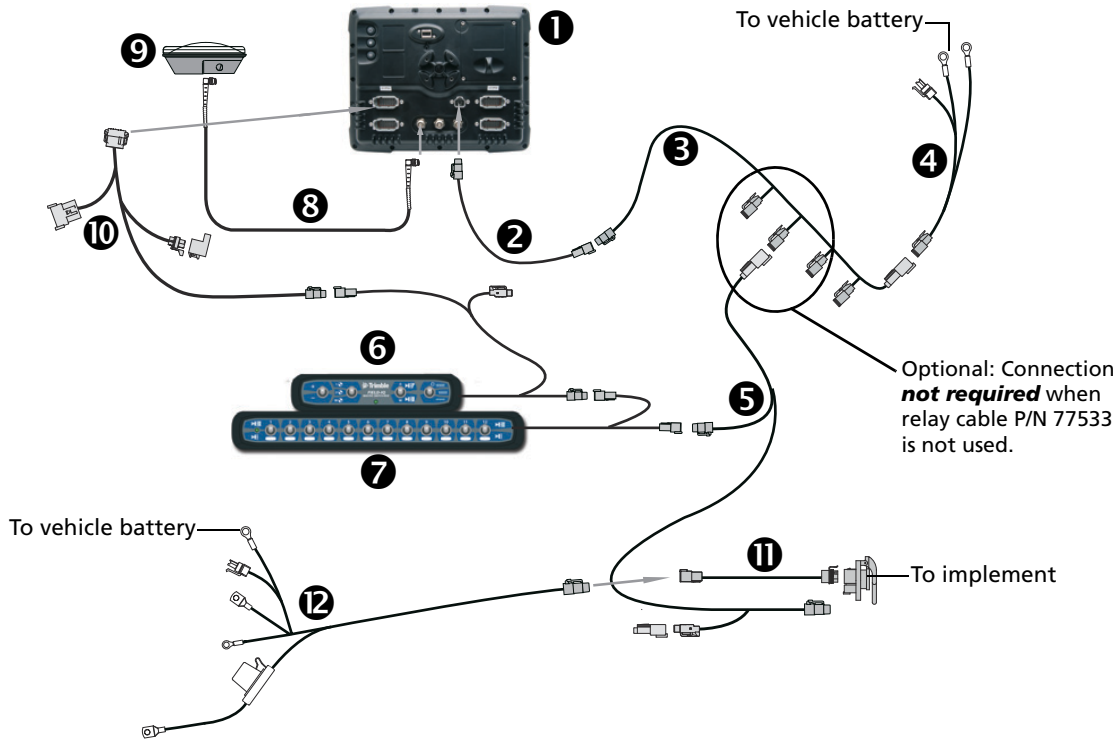

Item	Description	Trimble part number
1	FmX integrated display	93100-02
2	FmX power cable	66694
3	FmX power cable with relay and switch (power bus)	67259
4	Basic power cable	67258
5	Cab to hitch CAN cable	77368
6	Field-IQ master switch box	75050-01
7	12 section switch box (optional)	75060-01
8	8 m TNC/TMC right-angle GPS cable	50449
9	Ag25 GNSS antenna	77038-00
10	FmX integrated display to Field-IQ cable	75834
11	IBRC to DPT adapter cable (optional)	77413
12	Power to cab cable	76941

## FmX / Field-IQ cab kit / Powell hitch connector / power relay

Connecting the FmX integrated display, Field-IQ cab kit, power relay, and Powell hitch connector:

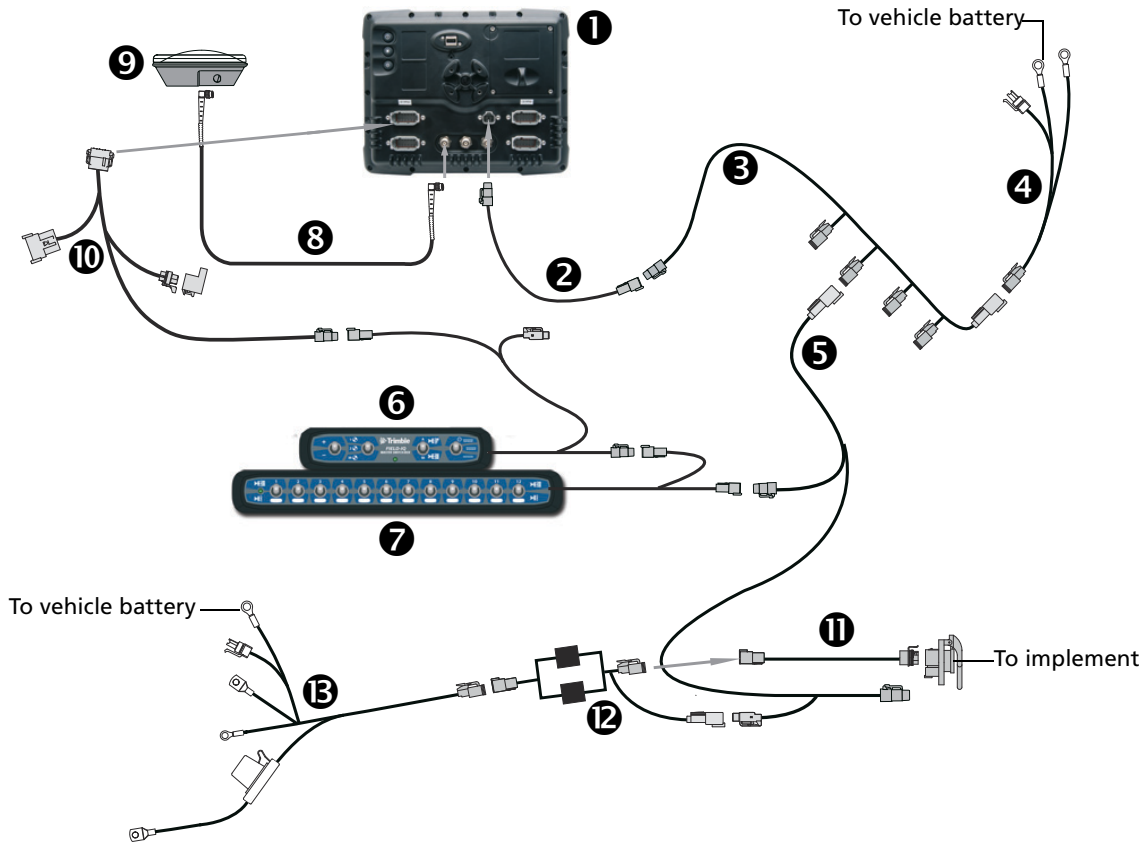

Item	Description	Trimble part number
❶	FmX integrated display	93100-02
❷	FmX power cable	66694
❸	FmX power cable with relay and switch (power bus)	67259
❹	Basic power cable	67258
❺	Cab to hitch CAN cable	77368
❻	Field-IQ master switch box	75050-01
❼	12 section switch box (optional)	75060-01
❽	8m TNC/TMC right-angle GPS cable	50449
❾	Ag25 GNSS antenna	77038-00
❿	FmX integrated display to Field-IQ cable	75834
⓫	IBRC to DPT adapter cable (optional)	77413
⓬	Dual relay power cutoff cable	77533
⓭	Power to cab cable	76941

## Field-IQ / Rawson Par 2 drives / Tru Count Air Clutch

This figure shows how to connect the Field-IQ system with the Rawson Par 2 drive, and the Tru Count Air Clutch®:

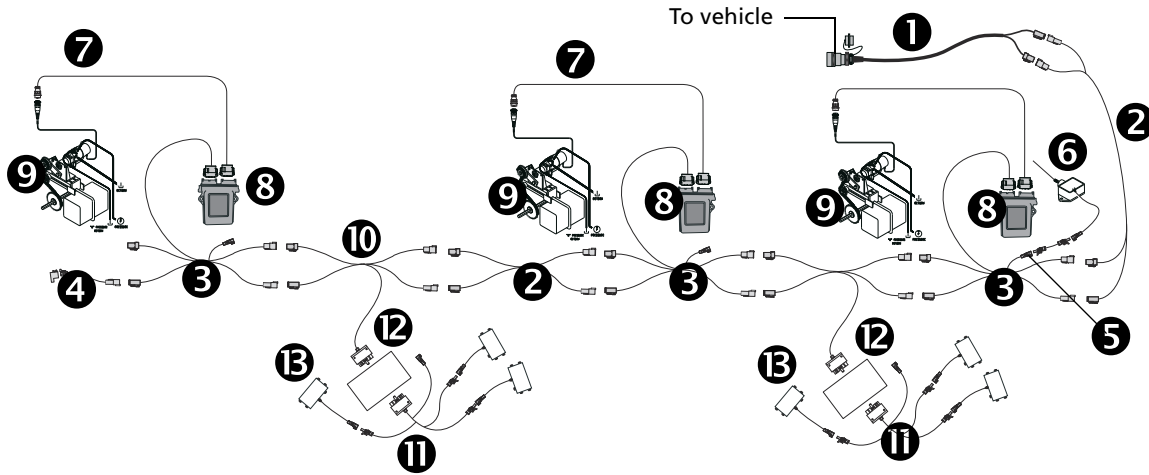

Item	Description	Trimble part number
❶	Implement harness (Powell adapter), optional	77611-01
❷	CAN/power extension cable	75528-xx
❸	Rawson module T-cable	75527
❹	Implement terminator kit (includes 75491)	75529
❺	20' Implement switch extension cable	77542
❻	Whisker switch	77636
❼	Rawson motor CPC to DTM cable	75531
❽	Rawson control module	75070-00
❾	Rawson PAR 2 motor	300499
❿	CAN-T Magnus cable	75524
⓫	Switching module to valve module cable	76859
⓬	Switch control module	75774-05
Ⓜ	Tru Count module	68355-00

## FmX / Field-IQ cab kit / Rawson PAR 40

Connecting the FmX integrated display with the Field-IQ cab kit and the Rawson PAR 40 motor:

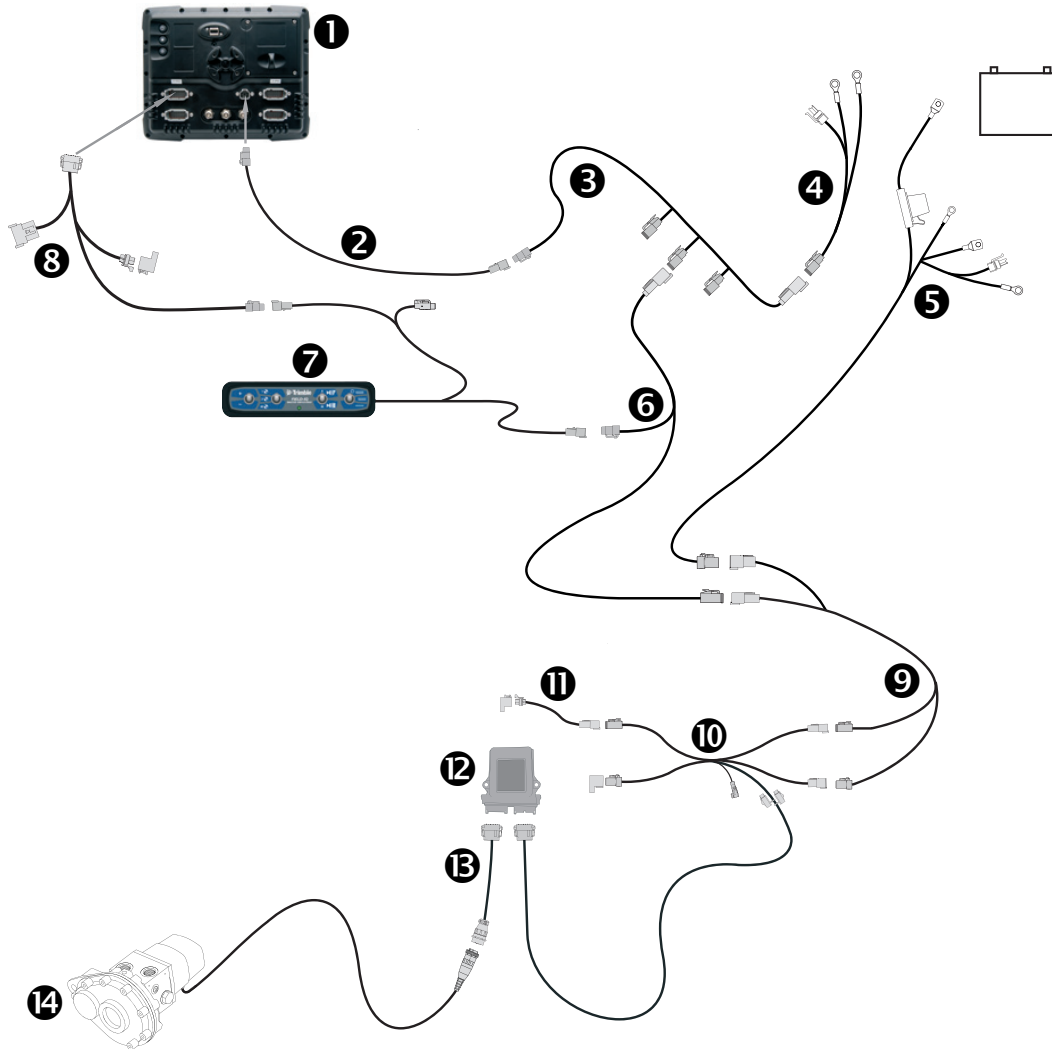

Item	Description	Trimble part number
1	FmX integrated display	93100-02
2	FmX power cable	66694
3	FmX power cable with relay and switch (power bus)	67259
4	Basic power cable	67258
5	Power to cab cable	76941
6	Cab to hitch CAN cable	77368
7	Field-IQ master switch box	75050-01
8	FmX integrated display to Field-IQ cable	75834
9	CAN to power extension cable	75528-xx
10	Rawson module Tee cable	75527
11	Implement terminator kit (includes 75491)	75529

Item	Description	Trimble part number
②	Rawson control module	75070-00
③	Rawson motor CPC to DTM cable	75531
④	Rawson PAR 40 motor	304152

## FmX / Autopilot / Field-IQ cab kit / Rawson PAR 40 / RTK Corrections

This figure shows how to connect the FmX integrated display with the Autopilot system, the Field-IQ cab kit and the Rawson PAR 40 motor, using RTK corrections:

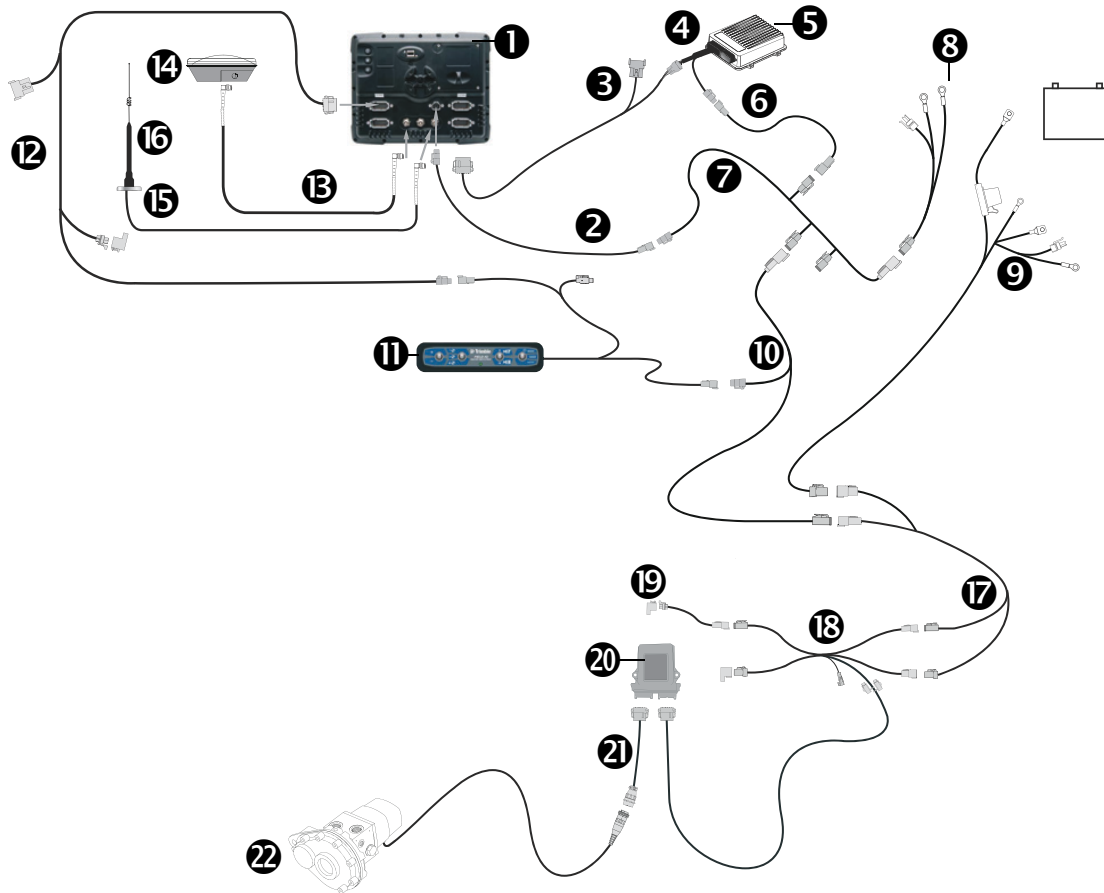

**CAUTION** – Connecting the Port Replicator on the FmX to NavController II cable ③ to the P4 or P12 connector of the NavController II harness ④ will result in damage to the FmX/FM-1000 integrated display, and will void the warranty.

Item	Description	Trimble part number
c	FmX integrated display	93100-02
d	FmX power cable	66694
e	FmX to NavController II cable with port replicator	75741
f	Main NavController II cable	54601
g	NavController II	55563-00
h	2 pin DTM to 2 pin DT power adaptor	67095
i	FmX power cable with relay and switch (power bus)	67259
j	Basic power cable	67258

Item	Description	Trimble part number
⑨	Power to cab cable	76941
⑩	Cab to hitch CAN cable	77368
⑪	Field-IQ master switch box	75050-01
⑫	FmX integrated display to Field-IQ cable	75834
⑬	8 m GPS TNC/TNC RT angle cable	50449
⑭	Ag25 GNSS antenna	77038-00
⑮	NMO to TNC 20ft antenna cable and base	62120
⑯	900 MHz radio antenna kit	22882-10
⑰	CAN to power extension cable	75528-xx
⑱	Rawson module Tee cable	75527
⑲	Implement terminator kit (includes 75491)	75529
⑳	Rawson control module	75070-00
㉑	Rawon motor CPC to DTM cable	75531
㉒	Rawson PAR 40 motor	304152

## FmX / Field-IQ Rate and Section control to Raven 4x0 or EZ-Boom harness

Connecting the FmX integrated display with Field-IQ Rate and Section Control and the Raven 4x0 or EZ-Boom cables:

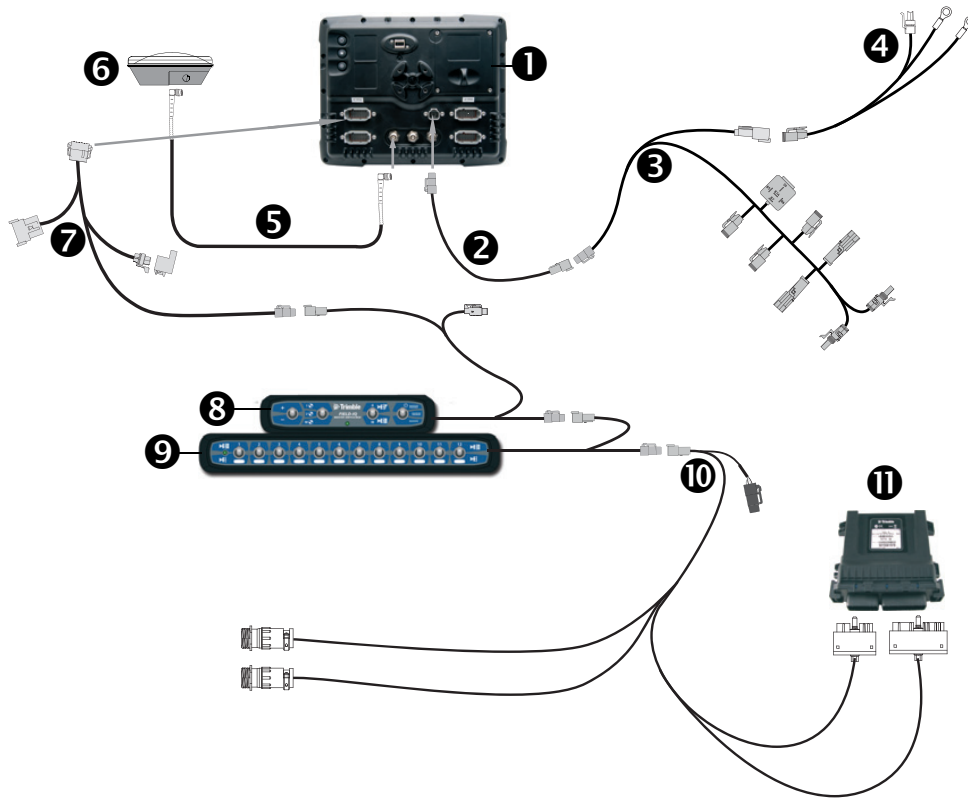

Item	Description	Trimble part number
❶	FmX integrated display	93100-01
❷	FmX power cable	66694
❸	Power bus	67259
❹	Basic power cable	67258
❺	8 m GPS TNC/TNC RT angle cable	50449
❻	Ag25 GNSS antenna	77038-00
❼	Display-to-Field-IQ cable	75834
❽	Field-IQ master switch box	75050-01
❾	12 section switch box (optional)	75060-01
❿	Rate and Section Control module adapter cable	75503
⓫	Rate and Section Control module	75774-00

## FmX / Field-IQ Section Control only to the Raven 4x0

This figure shows how to connect the FmX integrated display with Field-IQ Section Control only to the Raven 4x0 controller:

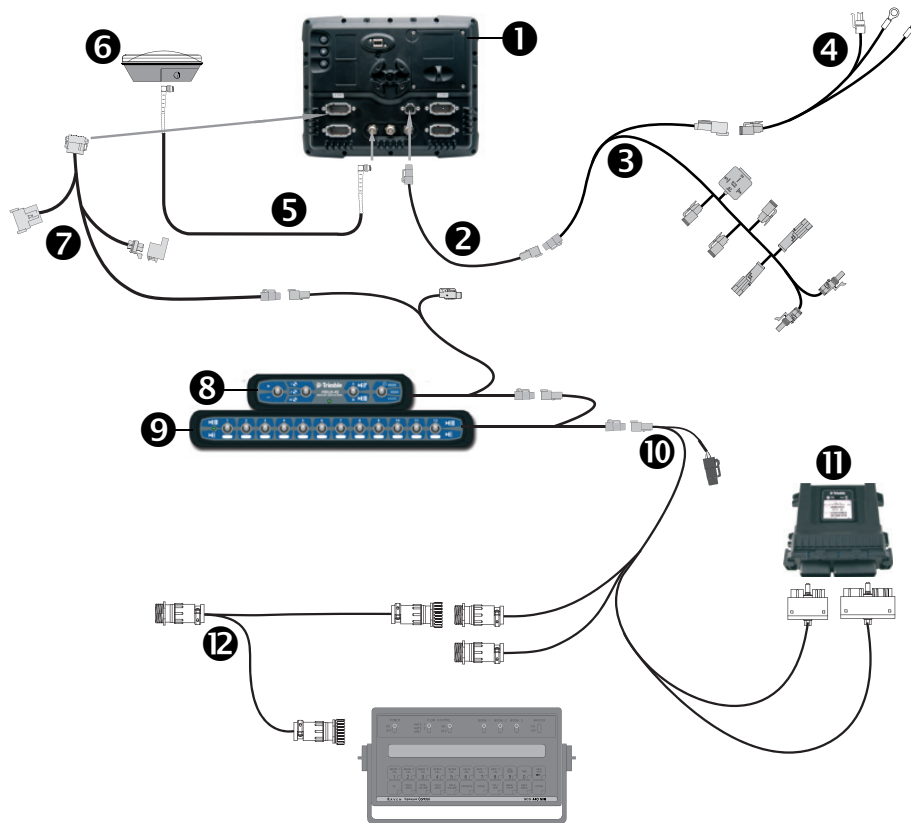

Item	Description	Trimble part number
❶	FmX integrated display	93100-01
❷	FmX power cable	66694
❸	Power bus	67259
❹	Basic power cable	67258
❺	8 m GPS TNC/TNC RT angle cable	50449
❻	Ag25 GNSS antenna	77038-00
❼	Display-to-Field-IQ cable	75834
❽	Field-IQ master switch box	75050-01
❾	12 section switch box (optional)	75060-01
❿	Rate and Section Control module adapter cable	75503
⓫	Rate and Section Control module	75774-00
⓬	Raven-to-EZ-Boom system 4x0 T-cable	79514

## FmX / Field-IQ Section Control to Raven 4x00

Connecting the FmX integrated display with Field-IQ Section Control to the Raven 4x00 controller:

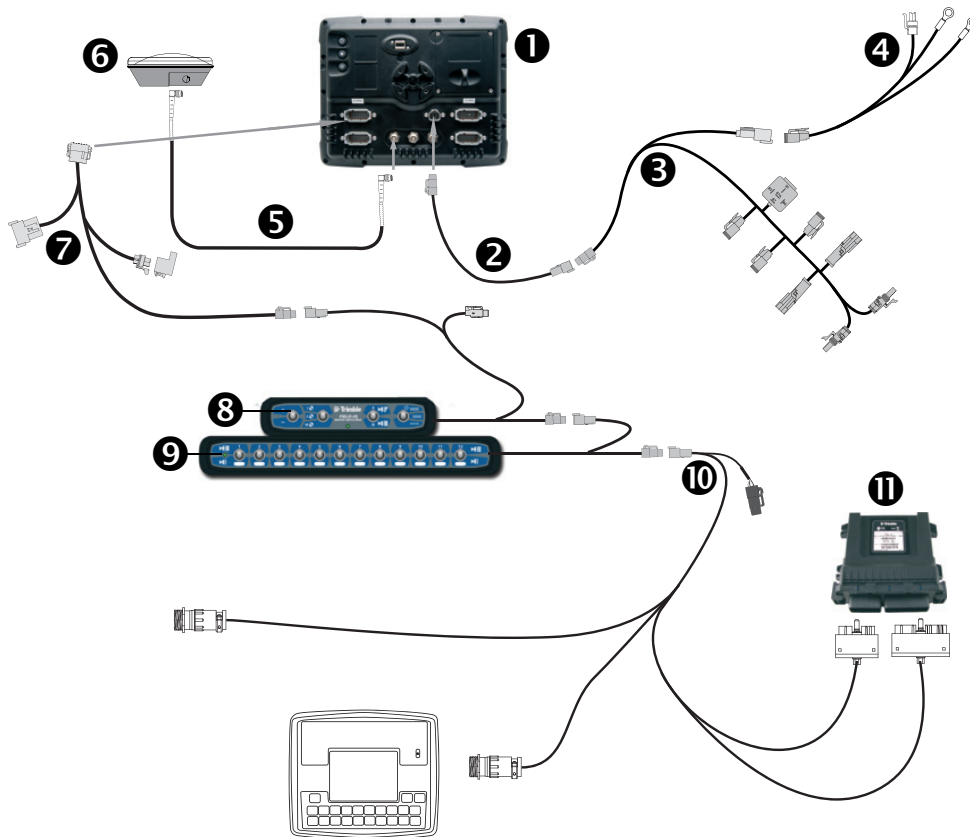

Item	Description	Trimble part number
❶	FmX integrated display	93100-01
❷	FmX power cable	66694
❸	Power bus	67259
❹	Basic power cable	67258
❺	8 m GPS TNC/TNC RT angle cable	50449
❻	Ag25 GNSS antenna	77038-00
❼	Display-to-Field-IQ cable	75834
❽	Field-IQ master switch box	75050-01
❾	12 section switch box (optional)	75060-01
❿	Rate and Section Control module adapter cable	79854
⓫	Rate and Section Control module	75774-00

## FmX / Field-IQ Rate and Section Control to Raven 4x00

Connecting the FmX integrated display with Field-IQ Rate and Section Control and the Raven 4x00 cables:

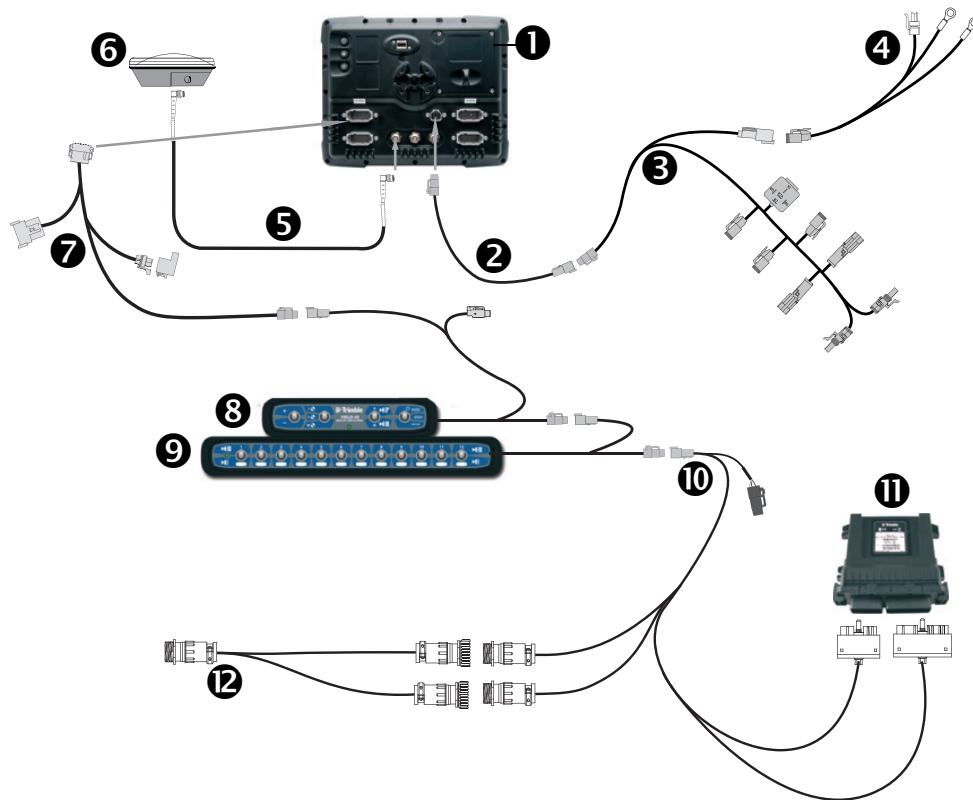

Item	Description	Trimble part number
❶	FmX integrated display	93100-01
❷	FmX power cable	66694
❸	Power bus	67259
❹	Basic power cable	67258
❺	8 m GPS TNC/TNC RT angle cable	50449
❻	Ag25 GNSS antenna	77038-00
❼	Display-to-Field-IQ cable	75834
❽	Field-IQ master switch box	75050-01
❾	12 section switch box (optional)	75060-01
❿	Rate and Section Control module adapter cable	75503
⓫	Rate and Section Control module	75774-00
⓬	Raven 4x0-to-4x00 harness adapter	59943

## FmX / Field-IQ Rate and Section Control for CaseIH SPX (2009 and later) sprayers

Connecting the FmX integrated display with Field-IQ Rate and Section Control for Case IH SPX sprayers (2009 or later):

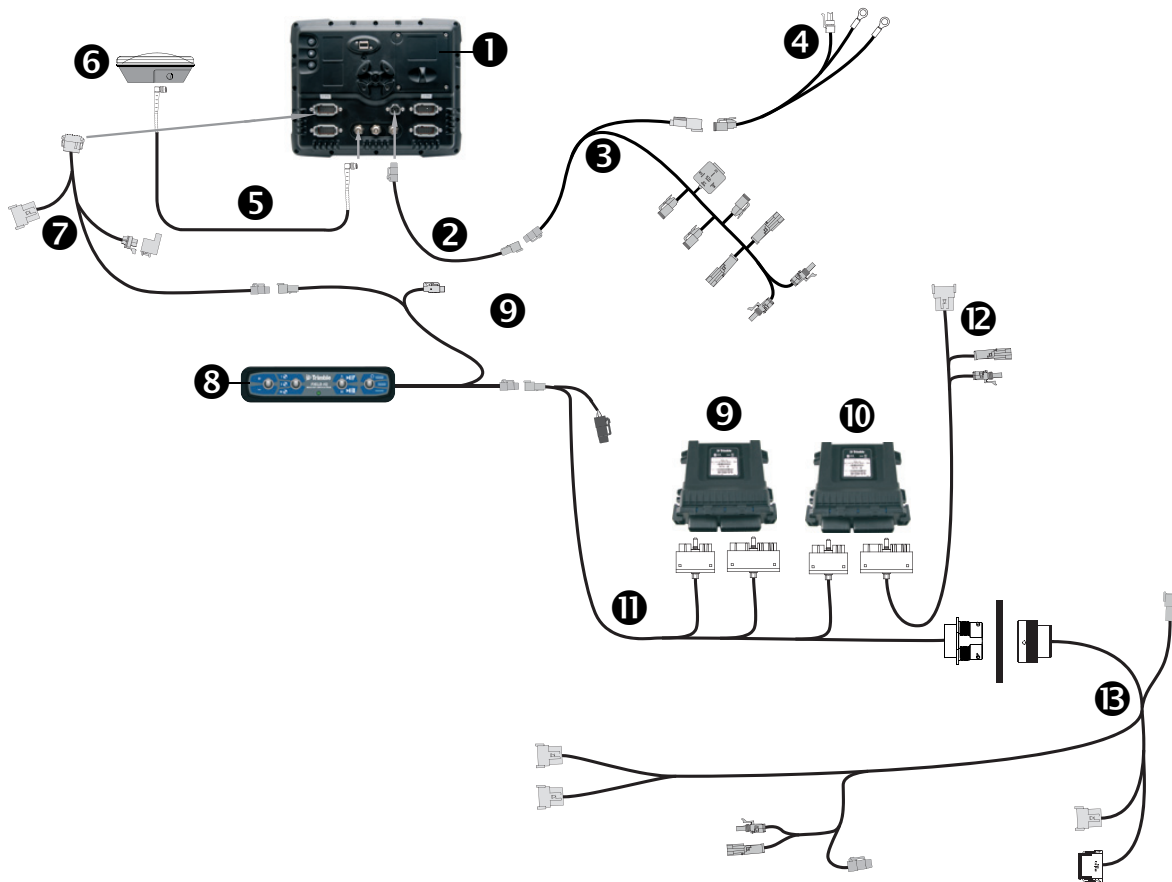

Item	Description	Trimble part number
①	FmX integrated display	93100-01
②	FmX power cable	66694
③	Power bus	67259
④	Basic power cable	67258
⑤	8 m GPS TNC/TNC RT angle cable	50449
⑥	Ag25 GNSS antenna	77038-00
⑦	Display-to-Field-IQ cable	75834
⑧	Field-IQ master switch box	75050-01
⑨	Rate and section control module	75774-00
⑩	Signal input module	76774-00
⑪	Field-IQ-to-sprayer cab cable	80099
⑫	Field-IQ SPX switch input cable (2009 and later)	80254
⑬	Field-IQ SPX chassis harness cable (2009 and later)	80250

## FmX / Field-IQ Rate and Section Control to AGCO RoGator (2007 and later)

Connecting the FmX integrated display, Field-IQ Rate and Section Control and AGCO RoGator:

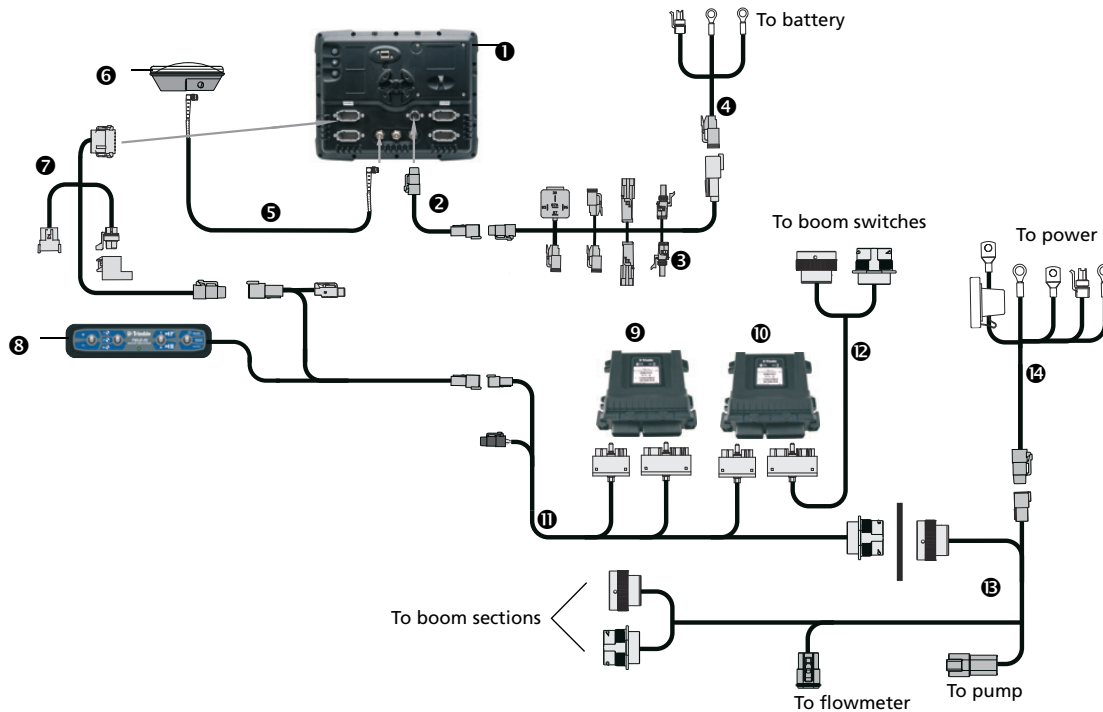

Item	Description	Trimble part number
1	FmX integrated display	93100-01
2	FmX power cable	66694
3	Power bus	67259
4	Basic power cable	67258
5	8 m GPS TNC/TNC RT angle cable	50449
6	Ag25 GNSS antenna	77038-00
7	Display-to-Field-IQ cable	75834
8	Field-IQ master switch box	75050-01
9	Rate and section control module	75774-00
10	Signal input module	76774-00
11	Field-IQ-to-sprayer cab cable	80099
12	Field-IQ-to-RoGator switch input cable	80347
13	Field-IQ-to-RoGator chassis harness cable	80417
14	Field-IQ-to-power cab cable	76941

## FmX / Field-IQ cab kit / NH3 and liquid application full harness

Connecting the FmX integrated display to the Field-IQ cab kit and the Rate and Section Control module with full NH3/liquid harness:

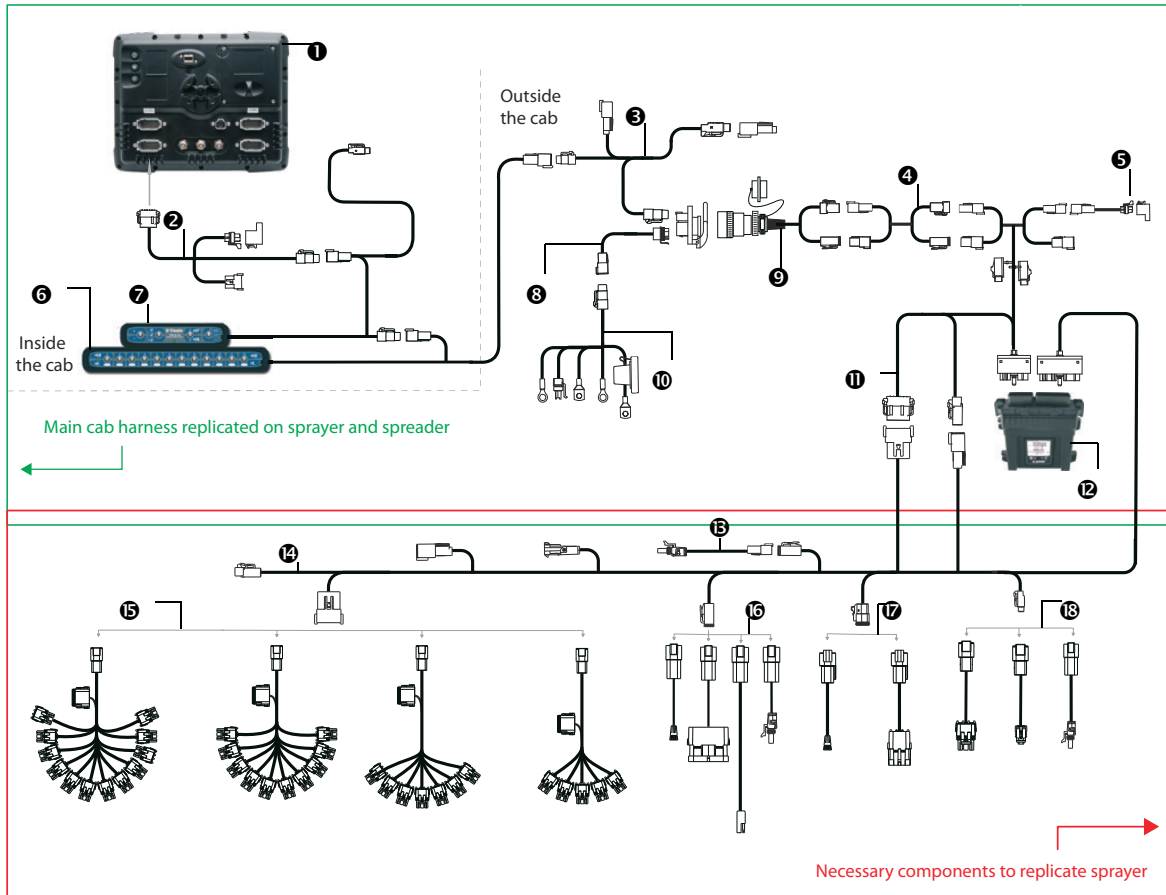

Item	Description	Trimble part number
❶	FmX integrated display	93100-01
❷	FmX power cable	66694
❸	Cab to hitch CAN cable	77368
❹	CAN/power extension cable	75528-xx
❺	Field-IQ implement terminator adapter	75529
❻	Field-IQ 12-section switch box, optional	75060-01
❼	Field-IQ master switch box	75050-01
❽	Powell quick disconnect (tractor side), optional	77413
❾	Implement harness (Powell adapter) - implement side, optional	77611-01
❿	Power to cab cable	76941
⓫	Power/CANbus harness	75526
⓬	Rate and section control module	75774-00

Item	Description	Trimble part number
⑬	Raven on/off valve adapter	81023
⑭	Field-IQ Rate and Section implement adapter	80540
⑮	Section valve adapter cable (left to right):	
	- Field-IQ to 12 section Raven adapter (3 wire)	80961
	- Field-IQ to 10 section Raven adapter (3 wire)	78225
	- Field-IQ to 7 section Raven adapter (3 wire)	77541
	- Field-IQ to 5 section Raven adapter (3 wire)	80587
⑯	Flow control adapter cable (left to right):	
	- Field-IQ to Raven fast valve	80534
	- Field-IQ to Dickey-john control valve (6 pin)	80531
	- Field-IQ to Raven control valve adapter (2 pin)	80586
	- Dickey-john PWM control valve adapter (2 wire)	80960
⑰	Flow meter cable:	
	- Field-IQ to Raven flowmeter adapter	80584
	- Field-IQ to Dickey-john encoder/flowmeter	80539
⑱	Pressure sensor cable (left to right):	
	- Field-IQ to Dickey-john pressure sensor adapter	80575
	- Field-IQ to Raven pressure sensor adapter	80583
	- Trimble pressure sensor adapter	54618

## FmX / Autopilot / Field-IQ cab kit / Spreader

Connecting the FmX integrated display, Field-IQ cab kit and the Rate and Section Control Module for spreader applications:

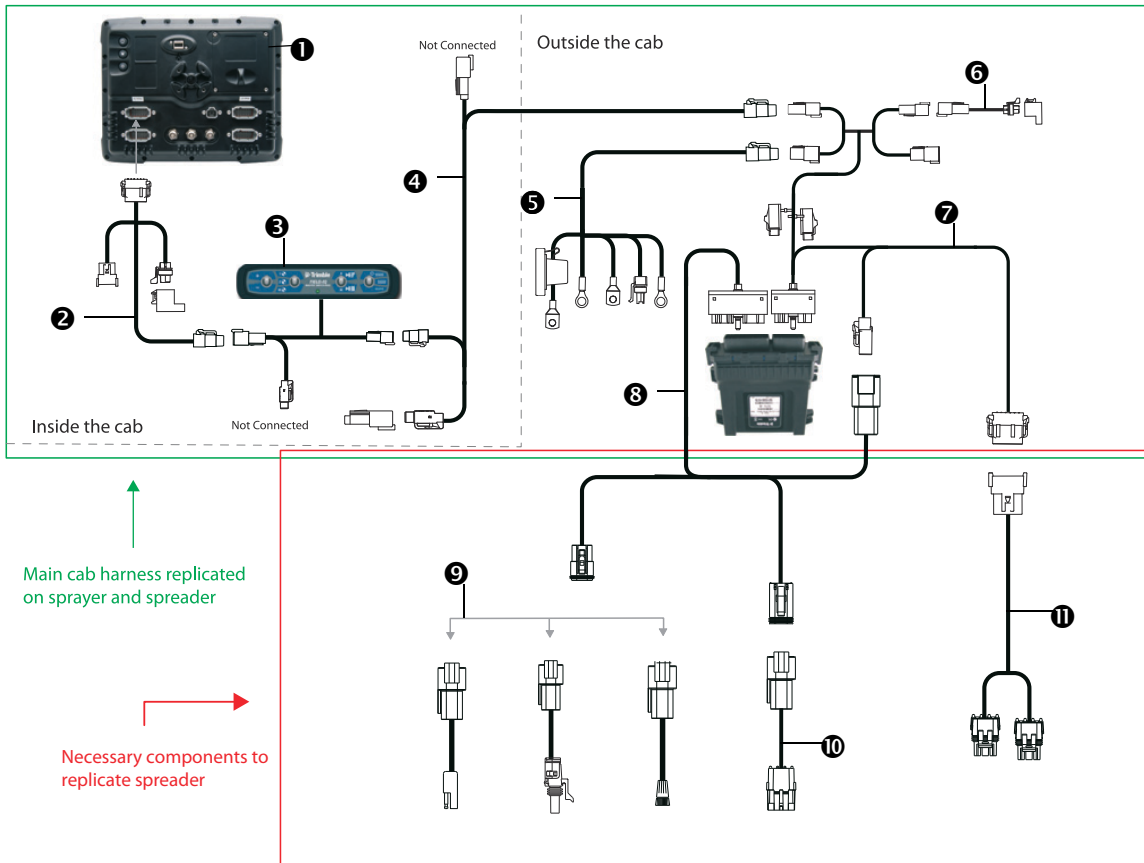

Item	Description	Trimble part number
1	FmX integrated display	93100-01
2	Display to Field-IQ cable	75834
3	Field-IQ master switch box	75050-01
4	Cab to hitch CAN cable	77368
5	Power to cab cable	76941
6	Field-IQ implement terminator adapter	75529
7	Power/CANbus harness	75526
8	Field-IQ universal spreader breakout cable	80553
9	Flow control adapter cable: - Field-IQ to Raven Fast Valve - Field-IQ to Raven control valve adapter - Dickey-john PWM control valve adapter (2 pin)	80534 80586 80960
10	Field-IQ to Dickey-john encoder/flowmeter	80539
11	Field-IQ, spreader gate height and spinner speed adapter cable	80507

## FmX / Field-IQ Cab Kit / Seed Monitoring Only

Connecting the FmX integrated display with Field-IQ cab kit and the Seed Monitoring module:

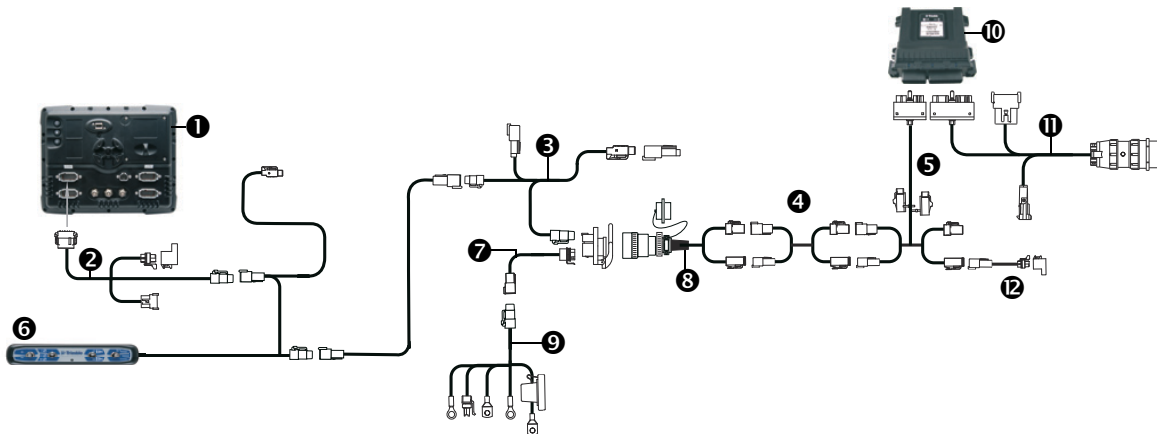

Item	Description	Trimble part number
❶	FmX integrated display	93100-01
❷	Display to Field-IQ cable	75834
❸	Cab to hitch CAN cable	77368
❹	CAN/Power extension cable	75528-XX
❺	Cable assembly, rate/section module tee	75526
❻	Field-IQ master switchbox	75050-01
❼	Powell Quick Disconnect (Tractor Side) (optional)	77413
❽	Implement harness (Powell adapter), implement side (optional)	77611-01
❾	Power to cab cable	76941
❿	Seed Monitoring Module (SMM)	76774-05
⓫	Existing population sensor harness adapters	
	Seed Monitoring Module Adapter PM style (24 or less rows)	82537
	Seed Monitoring Module Adapter PM style (25 -32 rows)	82539
	Seed Monitoring Module Adapter CT style (24 or less rows)	82536
	Seed Monitoring Module Adapter CT style (25 - 32 rows)	82538
⓬	Field-IQ implement terminator adapter	75529

## FmX / Field-IQ Cab Kit / Row Section Control

Connecting the FmX integrated display to the Field-IQ cab kit with the section-only control for Tru Count or John Deere row command clutches.

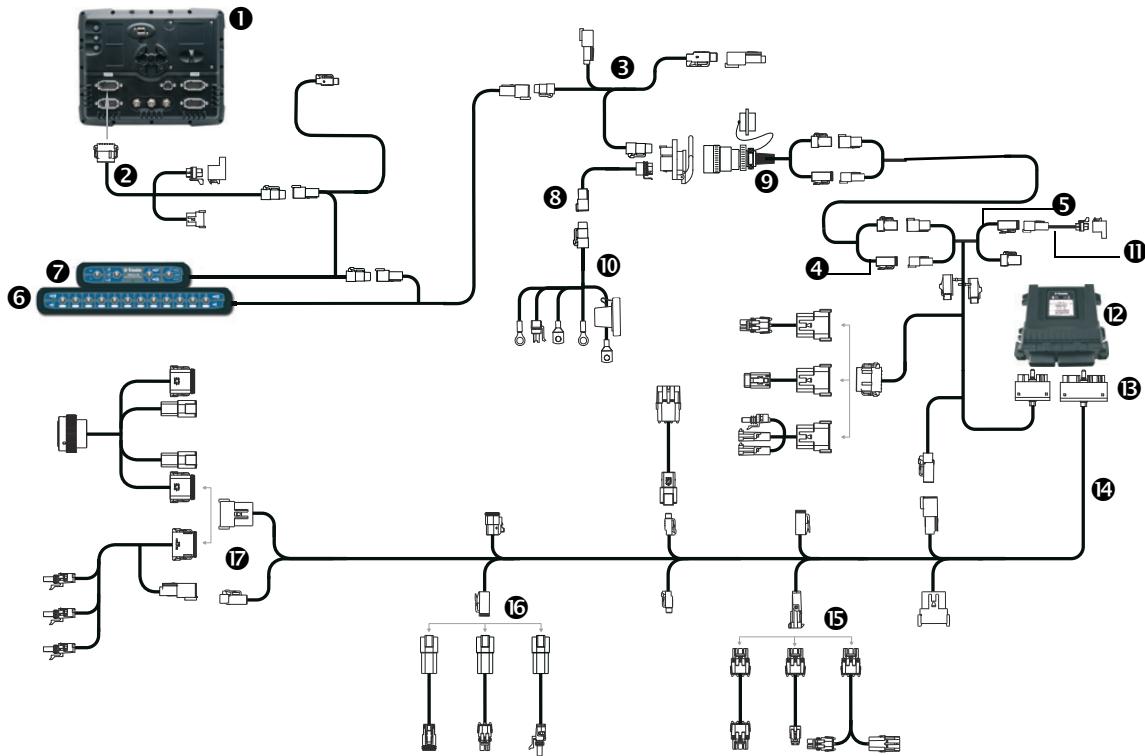

Item	Description	Trimble part number
①	FmX integrated display	93100-01
②	Display to Field-IQ cable	75834
③	Cab to hitch CAN cable	77368
④	CAN/Power extension cable	75528-XX
⑤	Cable Assy, rate/section module tee	75526
⑥	Field-IQ 12-section switchbox (optional)	75060-01
⑦	Field-IQ master switchbox	75050-01
⑧	Powell quick disconnect, tractor side (optional)	77413
⑨	Implement harness (Powell adapter), implement side (optional)	77611-01
⑩	Power to cab cable	76941
⑪	Field-IQ implement terminator adapter	75529
⑫	Section control module (II)	75774-10
⑬	Field-IQ rate and section implement adapter	80540

Item	Description	Trimble part number
14	Implement lift switch adapter	
	Field-IQ to John Deere implement lift switch	82743
	Field-IQ to Case IH implement switch	82922
	Field-IQ To Kinze implement switch	82924
	10' implement switch extension cable	77543
	Whisker switch	77636
15	Row section control adapter	
	Field-IQ to Tru Count breakout adapter	81693
	John Deere row command adapter cable (non-DB series)	82670
16	Vacuum / Pressure sensor adapter	
	Field-IQ to John Deere vacuum sensor	82744
	Trimble pressure sensor adapter	54618
17	Bin level sensor adapter and fan speed sensor adapter	
	Field-IQ to John Deere bin level sensor	82789
	Field-IQ to Case IH bin level sensor	82920
	White Bin/Hopper level sensor adapter	82928
	Case IH RPM sensor adapter	82923

## FmX / Field-IQ cab kit / Seed monitoring / Row section control

Connecting the FmX integrated display to the Field-IQ cab kit with the Seed Monitoring Module and Section only control for Tru Count or John Deere Row Command Clutches.

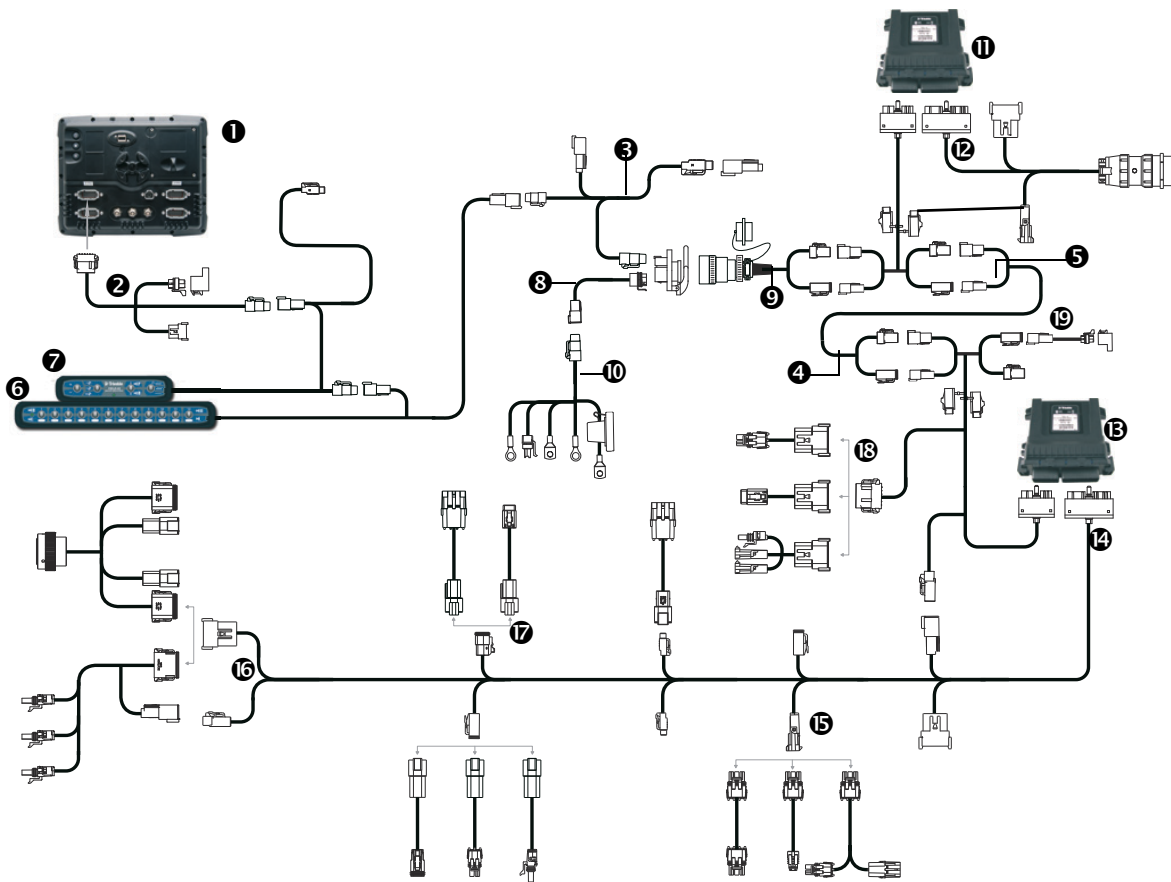

Item	Description	Trimble part number
❶	FmX integrated display	93100-01
❷	Display to Field-IQ cable	75834
❸	Cab to hitch CAN cable	77368
❹	CAN/Power extension cable	75528-XX
❺	Cable Assy, rate/section module tee	75526
❻	Field-IQ 12-section switchbox (optional)	75060-01
❼	Field-IQ master switchbox	75050-01
❽	Powell quick disconnect, tractor side (optional)	77413
❾	Implement harness (Powell adapter), implement side (optional)	77611-01
❿	Power to cab cable	76941
⓫	Seed Monitoring Module (SMM)	76774-05

Item	Description	Trimble part number
12	Existing population sensor harness adapters	
	Seed Monitoring Module Adapter PM style (24 or less rows)	82537
	Seed Monitoring Module Adapter PM style (25 -32 rows)	82539
	Seed Monitoring Module Adapter CT style (24 or less rows)	82536
	Seed Monitoring Module Adapter CT style (25 - 32 rows)	82538
13	Section control module (II)	76774-05
14	Field-IQ rate and section implement adapter	75774-10
15	Implement lift switch adapter	
	Field-IQ to John Deere implement lift switch	82743
	Field-IQ to Case IH implement switch	82922
	Field-IQ To Kinze implement switch	82924
	10' implement switch extension cable	77543
	Whisker switch	77636
16	Row section control adapter	
	Field-IQ to Tru Count breakout adapter	81693
	John Deere row command adapter cable (non-DB series)	82670
17	Vacuum / Pressure sensor adapter	
	Field-IQ to John Deere vacuum sensor	82744
	Trimble pressure sensor adapter	54618
18	Bin level sensor adapter and fan speed sensor adapter	
	Field-IQ to John Deere bin level sensor	82789
	Field-IQ to Case IH bin level sensor	82920
	White Bin/Hopper level sensor adapter	82928
	Case IH RPM sensor adapter	82923
19	Field-IQ implement terminator adapter	75529

## FmX / Field-IQ cab kit / Seed monitoring / Rate and Section Control

Connecting the FmX integrated display to the Field-IQ cab kit with the Seed Monitoring Module and Rate and Section control for Tru Count or John Deere Row Command Clutches with existing PWM drives.

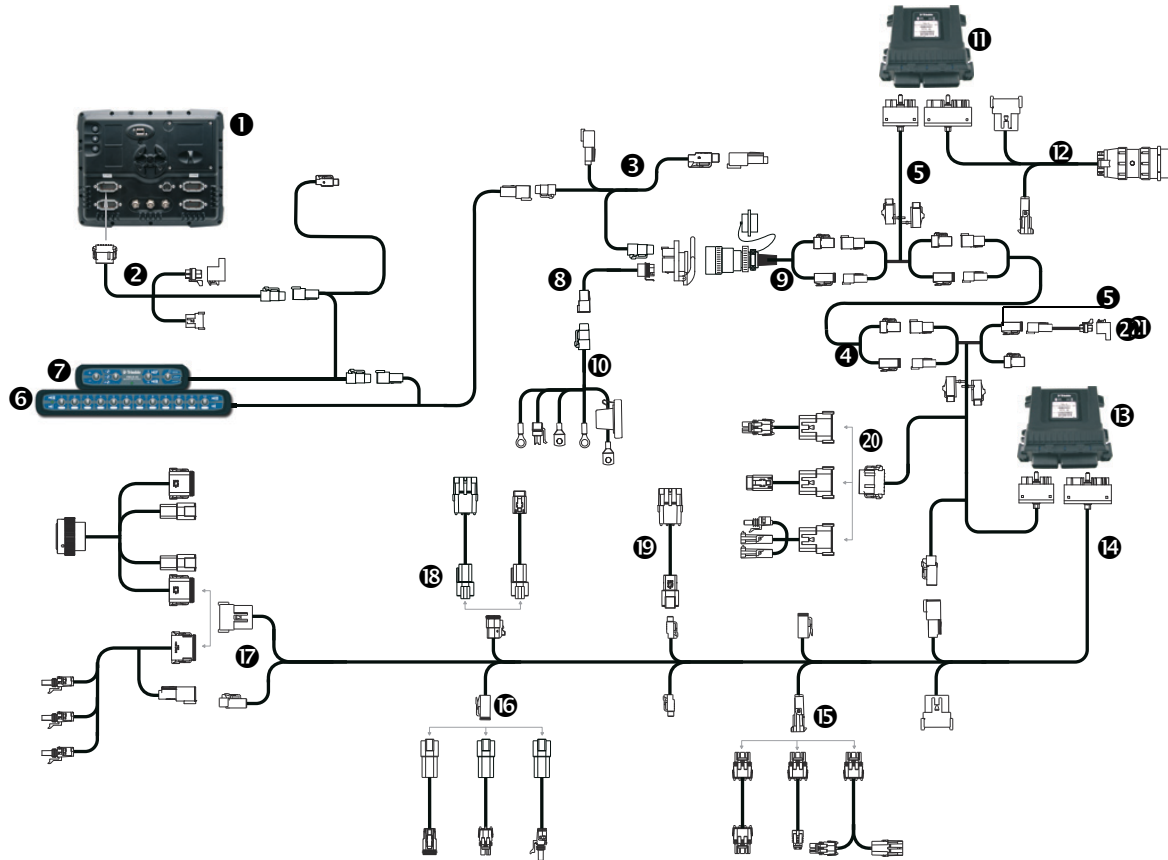

Item	Description	Trimble part number
❶	FmX integrated display	93100-01
❷	Display to Field-IQ cable	75834
❸	Cab to hitch CAN cable	77368
❹	CAN/Power extension cable	75528-XX
❺	Cable Assy, rate/section module tee	75526
❻	Field-IQ 12-section switchbox (optional)	75060-01
❼	Field-IQ master switchbox	75050-01
❽	Powell quick disconnect, tractor side (optional)	77413
❾	Implement harness (Powell adapter), implement side (optional)	77611-01
❿	Power to cab cable	76941
⓫	Seed Monitoring Module (SMM)	76774-05

Item	Description	Trimble part number
12	Existing population sensor harness adapters	
	Seed Monitoring Module Adapter PM style (24 or less rows)	82537
	Seed Monitoring Module Adapter PM style (25 -32 rows)	82539
	Seed Monitoring Module Adapter CT style (24 or less rows)	82536
	Seed Monitoring Module Adapter CT style (25 - 32 rows)	82538
13	Rate and section control module)	75774-00
14	Field-IQ rate and section implement adapter	80540
15	Implement lift switch adapter	
	Field-IQ to John Deere implement lift switch	82743
	Field-IQ to Case IH implement switch	82922
	Field-IQ To Kinze implement switch	82924
	10' implement switch extension cable	77543
	Whisker switch	77636
16	PWM drive adapter	
	Field-IQ to Kinze 2-wire/John Deere PWM	82706
	Field-IQ to Case IH/Kinze PWM	82919
	DJ PWM, control valve adapter	80960
17	Row section control adapter	
	Field-IQ to Tru Count breakout adapter	81693
	John Deere row command adapter cable (non-DB series)	82670
18	Application rate sensor adapter	
	Field-IQ to Dickey-john Encoder/Flowmeter (JD/Case IH/Kinze)	80539
	Field-IQ to Case IH application rate sensor	82921
19	Vacuum / Pressure sensor adapter	
	Field-IQ to John Deere vacuum sensor	82744
	Trimble pressure sensor adapter	54618
20	Bin level sensor adapter and fan speed sensor adapter	
	Field-IQ to John Deere bin level sensor	82789
	Field-IQ to Case IH bin level sensor	82920
	White Bin/Hopper level sensor adapter	82928
	Case IH RPM sensor adapter	82923
21	Field-IQ implement terminator adapter	75529

# FmX / Field-IQ cab kit / Seed monitoring / Rate and Section Control/ Liquid Control

Connecting the FmX integrated display to the Field-IQ cab kit with the Seed Monitoring Module and Rate and Section control for Tru Count or John Deere Row Command Clutches with existing PWM drives. Liquid control is added using the Rate and Section Control Module and adapter cables.

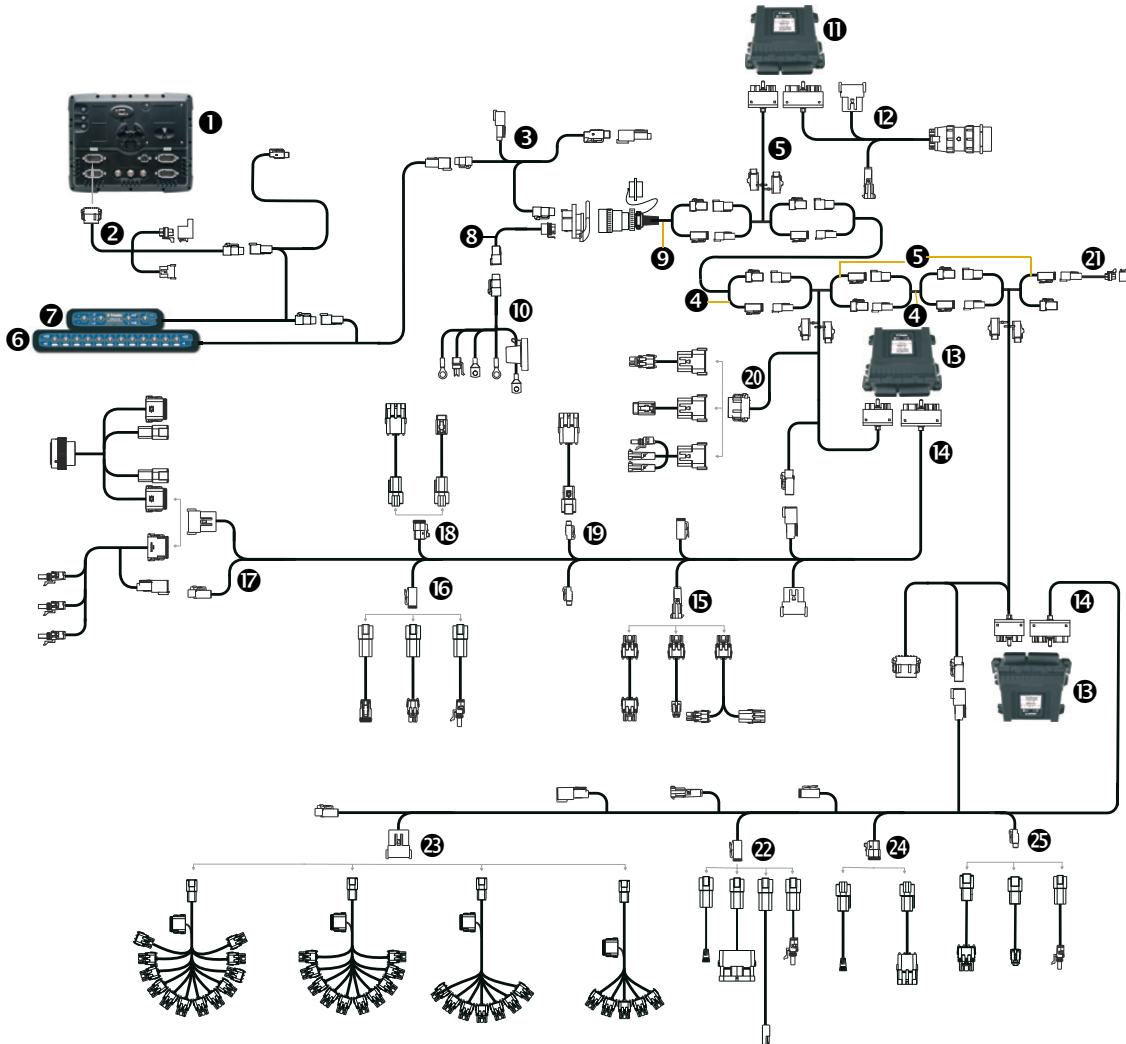

Item	Description	Trimble part number
1	FmX integrated display	93100-01
2	Display to Field-IQ cable	75834
3	Cab to hitch CAN cable	77368
4	CAN/Power extension cable	75528-XX
5	Cable Assy, rate/section module tee	75526
6	Field-IQ 12-section switchbox (optional)	75060-01
7	Field-IQ master switchbox	75050-01
8	Powell quick disconnect, tractor side (optional)	77413

Item	Description	Trimble part number
⑨	Implement harness (Powell adapter), implement side (optional)	77611-01
⑩	Power to cab cable	76941
⑪	Seed Monitoring Module (SMM)	76774-05
⑫	Existing population sensor harness adapters	
	Seed Monitoring Module Adapter PM style (24 or less rows)	82537
	Seed Monitoring Module Adapter PM style (25 -32 rows)	82539
	Seed Monitoring Module Adapter CT style (24 or less rows)	82536
	Seed Monitoring Module Adapter CT style (25 - 32 rows)	82538
⑬	Rate and section control module	75774-00
⑭	Field-IQ rate and section implement adapter	80540
⑮	Implement lift switch adapter	
	Field-IQ to John Deere implement lift switch	82743
	Field-IQ to Case IH implement switch	82922
	Field-IQ To Kinze implement switch	82924
	10' implement switch extension cable	77543
	Whisker switch	77636
⑯	PWM drive adapter	
	Field-IQ to Kinze 2-wire/John Deere PWM	82706
	Field-IQ to Case IH/Kinze PWM	82919
	Dickey-john PWM, control valve adapter	80960
⑰	Row section control adapter	
	Field-IQ to Tru Count breakout adapter	81693
	John Deere row command adapter cable (non-DB series)	82670
⑱	Application rate sensor adapter	
	Field-IQ to Dickey-john Encoder/Flowmeter (JD/Case IH/Kinze)	80539
	Field-IQ to Case IH application rate sensor	82921
⑲	Vacuum / Pressure sensor adapter	
	Field-IQ to John Deere vacuum sensor	82744
	Trimble pressure sensor adapter	54618
⑳	Bin level sensor adapter and fan speed sensor adapter	
	Field-IQ to John Deere bin level sensor	82789
	Field-IQ to Case IH bin level sensor	82920
	White Bin/Hopper level sensor adapter	82928
	Case IH RPM sensor adapter	82923
㉑	Field-IQ implement terminator adapter	75529

Item	Description	Trimble part number
22	Flow Control Adapter	
	Field-IQ to Raven fast valve (new style)	80534
	Field-IQ to Dickey-john control valve (6 pin)	80531
	Field-IQ to Raven control valve adapter (2 pin)	80586
	Dickey-john PWM control valve adapter (2 wire)	80960
	Control valve, Field-IQ to Kinze (4 Wire)	81614
	Field IQ to Raven fast valve (old style)	81554
	Field-IQ to Kinze 2 wire/John Deere PWM	82706
	Field-IQ To Raven standard valve (new style)	81970
23	Section Valve Adapter	
	Field-IQ to 5 section Raven adapter (3 wire)	80587
	Field-IQ to 7 section Raven adapter (3 wire)	77541
	Field-IQ to 10 section Raven adapter (3 wire)	78225
	Field-IQ to 12 section Raven adapter (3 wire)	80961
24	Flowmeter adapter	
	Field-IQ to Raven flowmeter adapter	80584
	Field-IQ to Dickey-john encoder/flowmeter	80539
25	Pressure sensor adapter	
	Field-IQ to Dickey-john pressure sensor adapter	80575
	Field-IQ to Raven pressure sensor adapter	80583
	Trimble pressure sensor adapter	54618

# FmX / Field-IQ Cab Kit / Seed Monitoring / Rawson PAR 2 Seeding

Connecting the FmX integrated display to the Field-IQ cab kit with the Seed Monitoring Module and Rawson PAR 2 Control System.

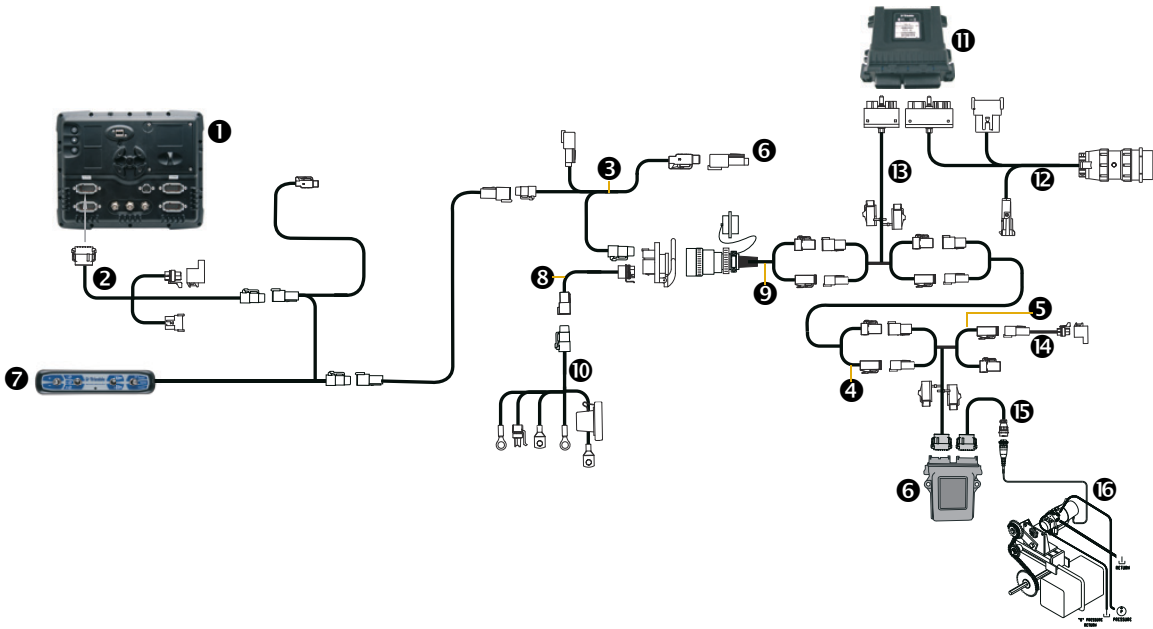

Item	Description	Trimble part number
❶	FmX integrated display	93100-01
❷	Display to Field-IQ cable	75834
❸	Cab to hitch CAN cable	77368
❹	CAN/Power extension cable	75528-XX
❺	Rawson Module Tee, Field-IQ	75527
❻	Rawson Control Module	75070-00
❼	Field-IQ master switchbox	75050-01
❽	Powell quick disconnect, tractor side (optional)	77413
❾	Implement harness (Powell adapter), implement side (optional)	77611-01
❿	Power to cab cable	76941
⓫	Seed Monitoring Module (SMM)	76774-05
⓬	Existing population sensor harness adapters	
	Seed Monitoring Module Adapter PM style (24 or less rows)	82537
	Seed Monitoring Module Adapter PM style (25 -32 rows)	82539
	Seed Monitoring Module Adapter CT style (24 or less rows)	82536
	Seed Monitoring Module Adapter CT style (25 - 32 rows)	82538
⓭	Cable Assy, Rate/section module tee	75526
⓮	Field-IQ Implement Terminator Adapter	75529

Item	Description	Trimble part number
⑤	Rawson motor CPC to DTM cable	75531
⑥	Rawson PAR 2 motor	300499

## FmX/Field-IQ Cab Kit / Seed Monitoring / Rawson PAR 2 Seeding / Row Section Control

Connecting the FmX integrated display to the Field-IQ cab kit with the Seed Monitoring Module, Rawson PAR 2 Control System and Section Control for Tru Count or John Deere Row Command Clutches.

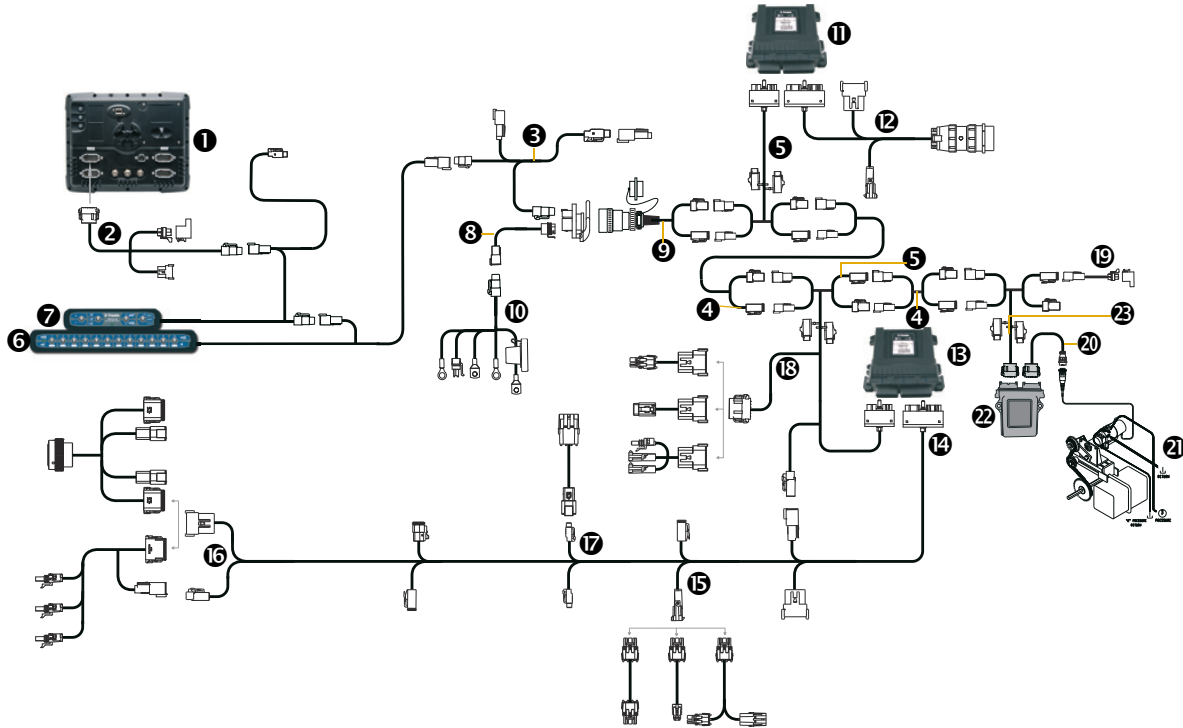

Item	Description	Trimble part number
1	FmX integrated display	93100-01
2	Display to Field-IQ cable	75834
3	Cab to hitch CAN cable	77368
4	CAN/Power extension cable	75528-XX
5	Cable Assy, rate/section module tee	75526
6	Field-IQ 12-section switchbox (optional)	75060-01
7	Field-IQ master switchbox	75050-01
8	Powell quick disconnect, tractor side (optional)	77413
9	Implement harness (Powell adapter), implement side (optional)	77611-01
10	Power to cab cable	76941
11	Seed Monitoring Module (SMM)	76774-05

Item	Description	Trimble part number
12	Existing population sensor harness adapters	
	Seed Monitoring Module Adapter PM style (24 or less rows)	82537
	Seed Monitoring Module Adapter PM style (25 -32 rows)	82539
	Seed Monitoring Module Adapter CT style (24 or less rows)	82536
	Seed Monitoring Module Adapter CT style (25 - 32 rows)	82538
13	Section control module (II)	75774-10
14	Field-IQ rate and section implement adapter	80540
15	Implement lift switch adapter	
	Field-IQ to John Deere implement lift switch	82743
	Field-IQ to Case IH implement switch	82922
	Field-IQ To Kinze implement switch	82924
	10' implement switch extension cable	77543
	Whisker switch	77636
16	Row section control adapter	
	Field-IQ to Tru Count breakout adapter	81693
	John Deere row command adapter cable (non-DB series)	82670
17	Vacuum / Pressure sensor adapter	
	Field-IQ to John Deere vacuum sensor	82744
	Trimble pressure sensor adapter	54618
18	Bin level sensor adapter and fan speed sensor adapter	
	Field-IQ to John Deere bin level sensor	82789
	Field-IQ to Case IH bin level sensor	82920
	White Bin/Hopper level sensor adapter	82928
	Case IH RPM sensor adapter	82923
19	Field-IQ implement terminator adapter	75529
20	Rawson motor CPC to DTM cable	75531
21	Rawson PAR 2 motor	300499
22	Rawson Control Module	75070-00
23	Rawson Module Tee, Field-IQ	75527

# Connecting to the GreenSeeker System

## In this chapter:

- [FmX / GreenSeeker](#)

This chapter shows how to connect the FmX integrated display to the GreenSeeker variable rate application and mapping system.

## FmX / GreenSeeker

This figure shows how to connect the FmX integrated display with the GreenSeeker system, while using WAAS or EGNOS corrections.

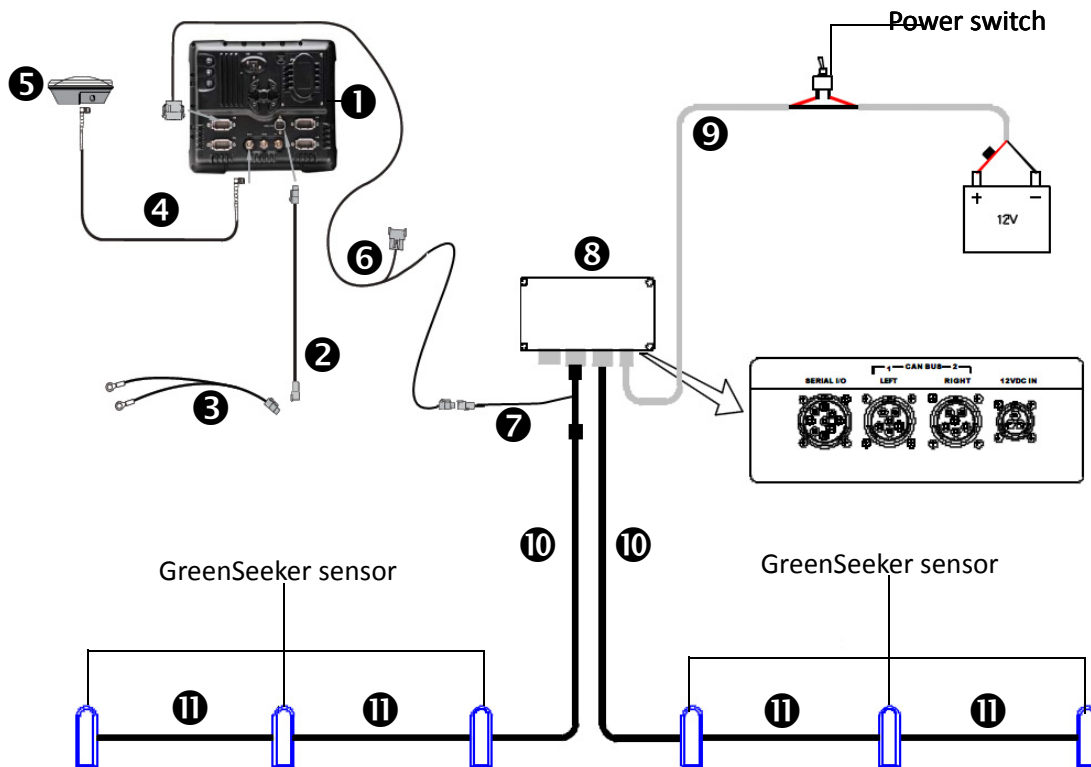

Item	Description	Trimble part number
❶	FmX integrated display	93100-01
❷	FmX power cable	66694
❸	FmX basic power cable	67258
❹	8 m GPS TNC/TNC RT angle cable	50449
❺	Ag25 GNSS antenna	77038-00
❻	Display to CAN with port replicator	75407
❼	GreenSeeker to display cable	77704
❽	RT200 interface module	900-1-047-EM
❾	30' RT200 power cable	400-1-276-EM
❿	20' RT200 interface module	400-1-277-EM
⓫	20' RT200 sensor cable	400-1-265-240-EM

# Connecting to the EZ-Boom System

## In this chapter:

- Manual guidance FmX / EZ-Boom
- FmX / Autopilot / EZ-Boom / RTK corrections
- FmX / Autopilot / EZ-Boom / TrueTracker / RTK corrections
- FmX / EZ-Boom / EZ-Steer / RTK corrections / power bus
- FmX / EZ-Boom / EZ-Steer / RTK corrections / external power leads

This chapter shows the different ways to connect the FmX integrated display to the EZ-Boom® automated application control system.



---

**CAUTION** – Connecting the Port Replicator on the FmX display to the NavController II cable to the P4 or P12 connector of the NavController II harness will result in damage to the FmX / FM-1000 integrated display, and will void the warranty.

---

## Manual guidance FmX / EZ-Boom

This figure shows how to connect the FmX integrated display with the EZ-Boom system, while using manual guidance:

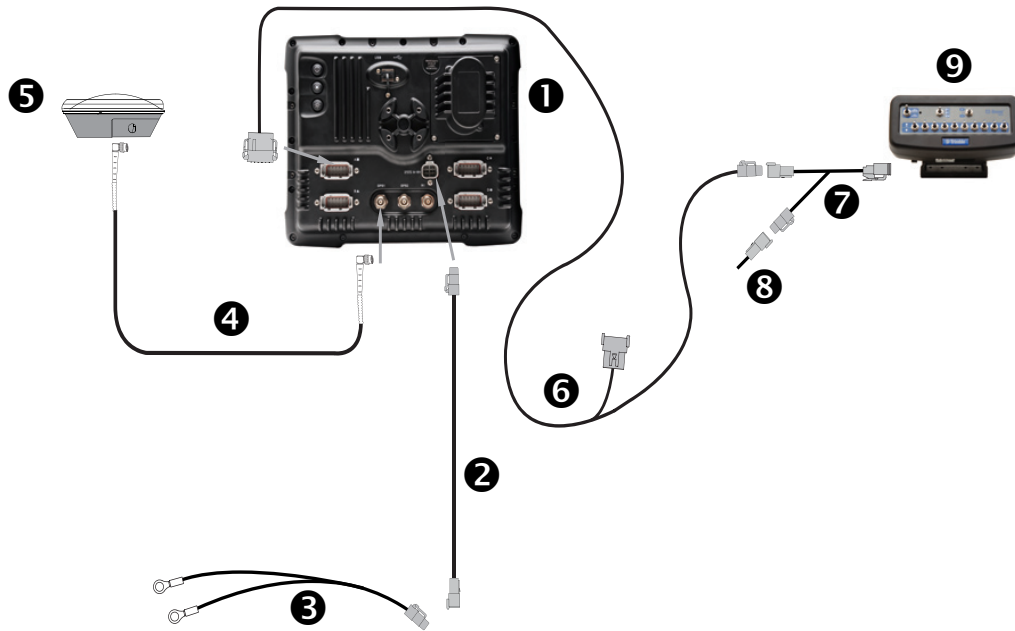

Item	Description	Trimble part number
❶	FmX integrated display	93100-01
❷	FmX power cable	66694
❸	FmX basic power cable	67258
❹	8 m GPS TNC/TNC RT angle cable	50449
❺	Ag25 GNSS antenna	77038-00
❻	FmX to CAN cable with port replicator	75407
❼	EZ-Boom 2010 to FMD and EZ-Guide 500 cable	61437
❽	CAN terminator	59783
❾	EZ-Boom controller	59898-00

## FmX / Autopilot / EZ-Boom / RTK corrections

This figure shows how to connect the FmX integrated display with the Autopilot system and the EZ-Boom system, to use RTK corrections:

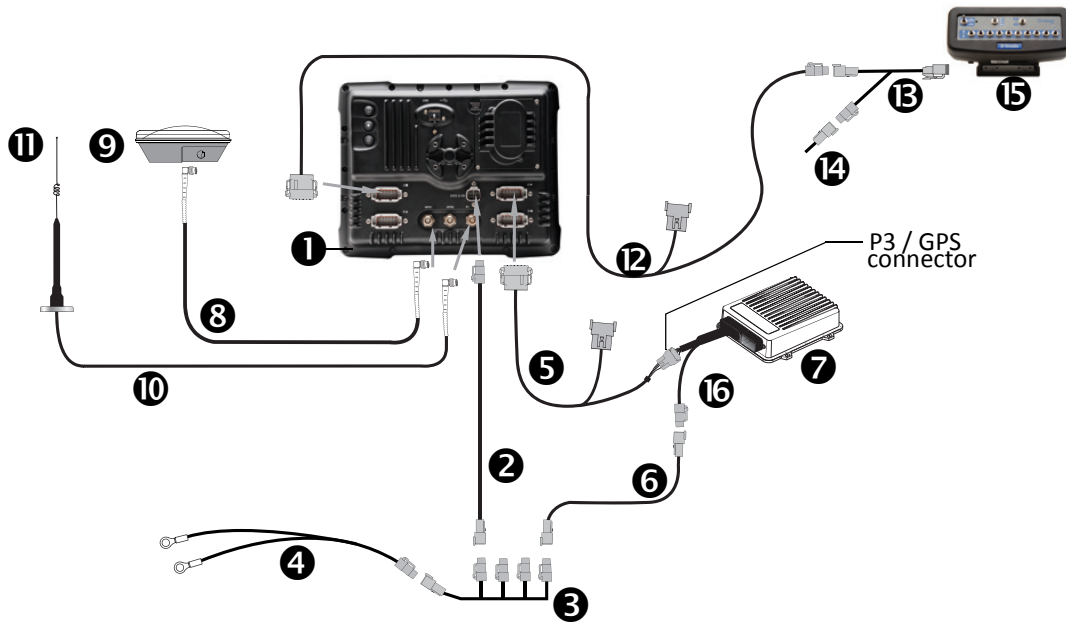

**CAUTION** – Connecting the Port Replicator on the FmX to NavController II cable **5** to the P4 or P12 connector of the NavController II harness **16** will result in damage to the FmX/FM-1000 integrated display, and will void the warranty.

Item	Description	Trimble part number
1	FmX integrated display	93100-02
2	FmX power cable	66694
3	FmX power cable with relay and switch (power bus)	67259
4	Basic power cable	67258
5	FmX to NavController II cable with port replicator	75741
6	2 pin DTM to 2 pin DT power adaptor	67095
7	NavController II	55563-00
8	8 m GPS TNC/TNC RT angle cable	50449
9	Ag25 GNSS antenna	77038-00
10	NMO to TNC 20 ft antenna cable and base	62120
11	900 MHz radio antenna kit	22882-10
12	FmX to CAN cable with port replicator	75407
13	EZ-Boom 2010 to FMD and EZ-Guide 500 cable	61437
14	CAN terminator	59783
15	EZ-Boom controller	59898-00
16	Main NavController II cable	54601

## FmX / Autopilot / EZ-Boom / TrueTracker / RTK corrections

This figure shows how to connect the FmX integrated display with the Autopilot system and TrueTracker and EZ-Boom systems, while using RTK corrections:

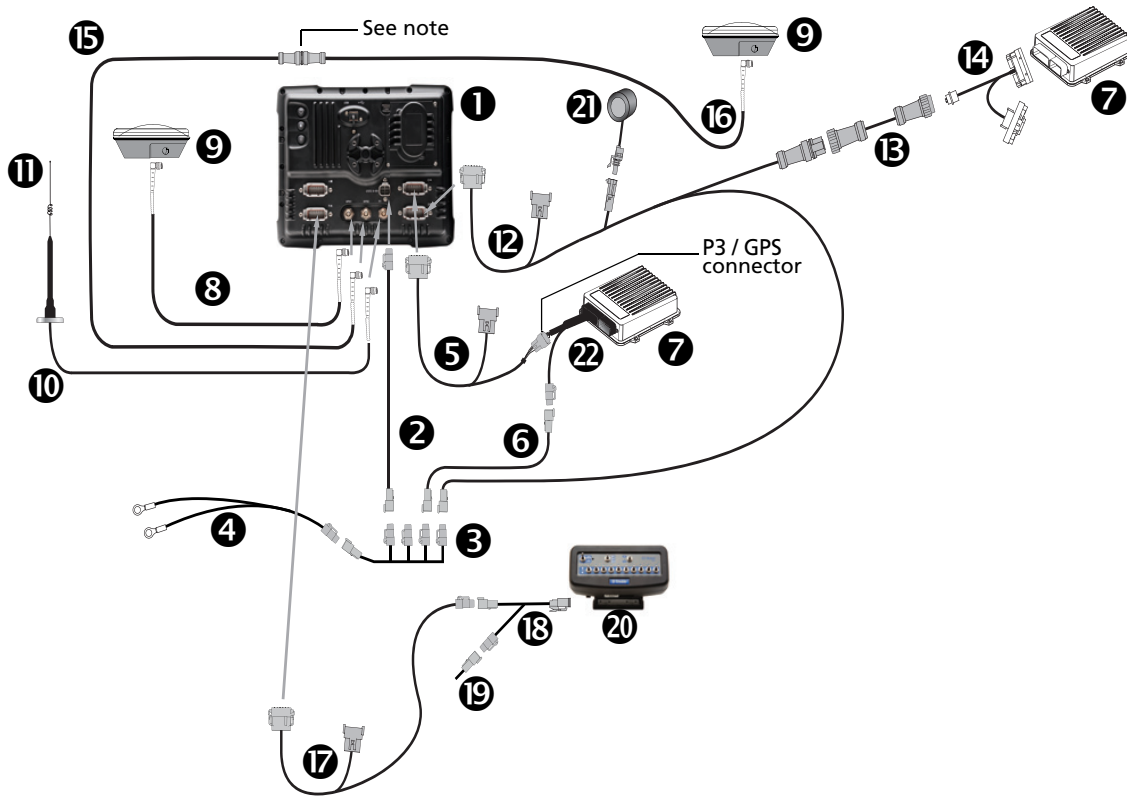

**CAUTION** – Connecting the Port Replicator on the FmX to NavController II cable ⑤ to the P4 or P12 connector of the NavController II harness ⑫ will result in damage to the FmX/FM-1000 integrated display, and will void the warranty.

**Note** – An optional LMR400 65' extension cable (P/N 67473) is available for implements with a long tongue.

Item	Description	Trimble part number
①	FmX integrated display	93100-02
②	FmX power cable	66694
③	FmX power cable with relay and switch (power bus)	67259
④	Basic power cable	67258
⑤	FmX to NavController II cable with port replicator	75741
⑥	2 pin DTM to 2 pin DT power adaptor	67095
⑦	NavController II (x2)	55563-00
⑧	8 m GPS TNC/TNC RT angle cable	50449

Item	Description	Trimble part number
9	Ag25 GNSS antenna (x2)	77038-00
10	NMO to TNC 20ft antenna cable and base	62120
11	900 MHz radio antenna kit	22882-10
12	FmX to TrueTracker cable	67092
13	Implement extension cable	0793-8740-450
14	FmX to NavController II and TrueTracker main harness	67612
15	Coaxial 160" N/f + TNC/m-ra cable	68295
16	Coaxial 480" N/m + TNC/m-ra cable	67472
17	FmX to CAN cable with port replicator	75407
18	EZ-Boom 2010 to FMD and EZ-Guide 500 cable	61437
19	CAN terminator	59783
20	EZ-Boom controller	59898-00
21	Sonalert	43104
22	Main NavController II cable	54601

## FmX / EZ-Boom / EZ-Steer / RTK corrections / power bus

This figure shows how to connect the FmX integrated display with the EZ-Steer and EZ-Boom systems to use RTK corrections:

**Note** – The EZ-Steer assisted steering system must be powered separately to power the motor.

**Note** – To use the EZ-Guide 500 lightbar cable (P/N 62974) and instructions on how to repin the cable, see the support bulletin AgGPS FmX - Modifying EZ-Steer Cable P/N 62974 For Use With FmX.

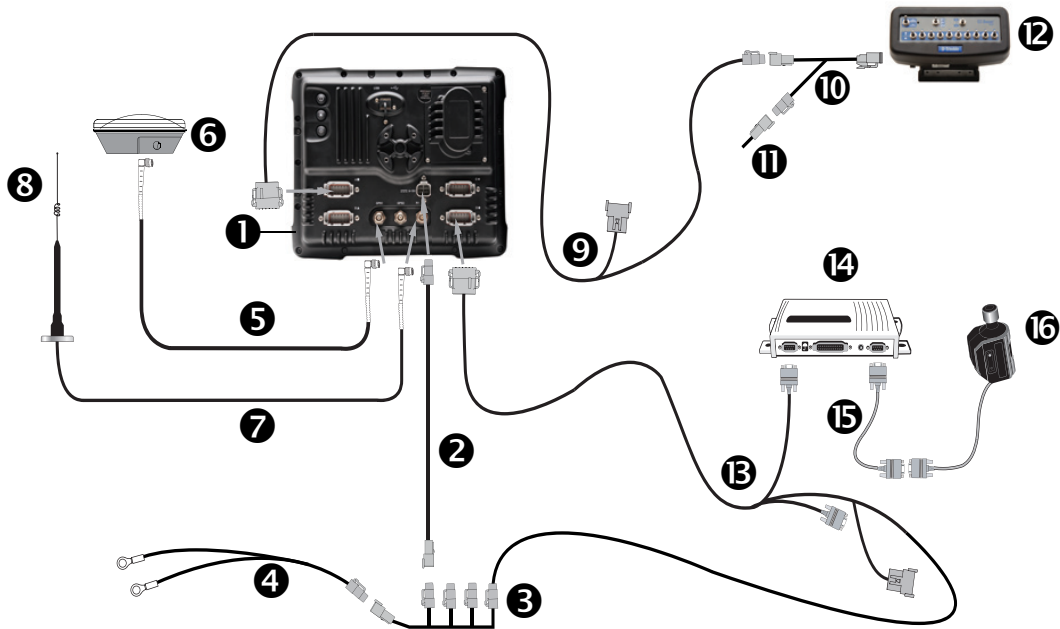

Item	Description	Trimble part number
❶	FmX integrated display	93100-02
❷	FmX power cable	66694
❸	FmX power cable with relay and switch (power bus)	67259
❹	FmX basic power cable	67258
❺	8 m GPS TNC/TNC RT angle cable	50449
❻	Ag25 GNSS antenna	77038-00
❼	NMO to TNC 20 ft antenna cable and base	62120
❽	900 MHz radio antenna kit	22882-10
❾	FmX to CAN cable with port replicator	75407
❿	EZ-Boom 2010 to FmX display and EZ-Guide 500 cable	61437
⓫	CAN terminator	59783
⓬	EZ-Boom controller	59898-00
⓭	FmX to EZ-Steer cable	75742
⓮	EZ-Steer controller	53348-10

Item	Description	Trimble part number
⑤	EZ-Steer motor cable	62257
⑥	EZ-Steer motor	53058-00

## FmX / EZ-Boom / EZ-Steer / RTK corrections / external power leads

This figure shows how to connect the FmX integrated display with the EZ-Boom and EZ-Steer systems with external power leads to use RTK corrections.

**Note** – The EZ-Steer assisted steering system must be powered separately to power the motor.

**Note** – To use the EZ-Guide 500 lightbar cable (P/N 62974) and instructions on how to repin the cable, see the support bulletin *AgGPS FmX - Modifying EZ-Steer Cable P/N 62974 For Use With FmX*.

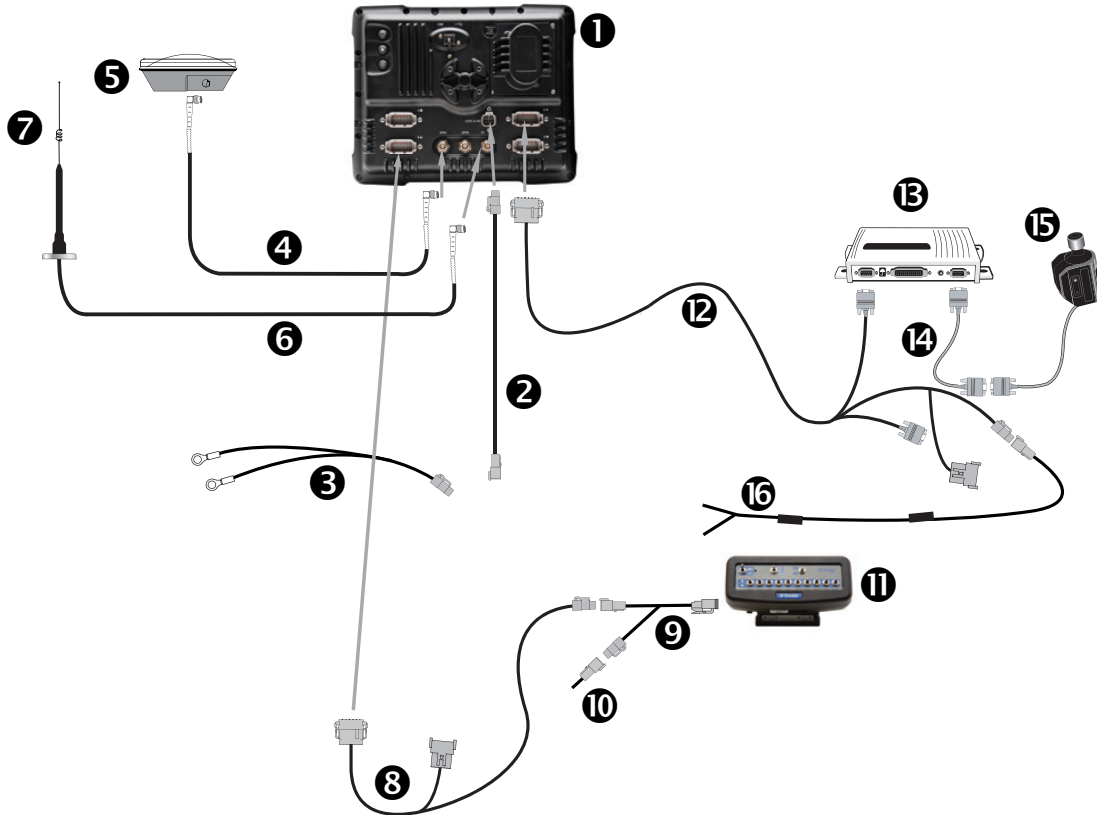

Item	Description	Trimble part number
1	FmX integrated display	93100-02
2	FmX power cable	66694
3	FmX basic power cable	67258
4	8 m GPS TNC/TNC RT angle cable	50449
5	Ag25 GNSS antenna	77038-00
6	NMO to TNC 20 ft antenna cable and base	62120
7	900 MHz radio antenna kit	22882-10
8	FmX to CAN cable with port replicator	75407
9	EZ-Boom 2010 to FMD and EZ-Guide 500 cable	61437
10	CAN terminator	59783

Item	Description	Trimble part number
①	EZ-Boom Controller	59898-00
②	FmX to EZ-Steer cable	75742
③	EZ-Steer controller	53348-10
④	EZ-Steer motor cable	62257
⑤	EZ-Steer motor	53058-00
⑥	Unterminated power cable	75743

# Connecting to Radar Output and Serial Control

## In this chapter:

- FmX / Autopilot / radar output / serial variable rate for Raven SCS400 or SCS600
- FmX / Autopilot / radar output / serial variable rate for Rawson
- FmX / Autopilot / radar output / serial variable rate
- FmX / Autopilot / serial connection for Hardi 5500 controller

This chapter shows the different ways to connect the FmX integrated display to equipment from third-party equipment for radar output and serial control.



---

**CAUTION** – Connecting the Port Replicator on the FmX display to the NavController II cable to the P4 or P12 connector of the NavController II harness will result in damage to the FmX / FM-1000 integrated display, and will void the warranty.

---

## FmX / Autopilot / radar output / serial variable rate for Raven SCS400 or SCS600

This figure shows how to connect the FmX integrated display with the Autopilot system, radar output, and serial variable rate for Raven SCS400 or SCS600:

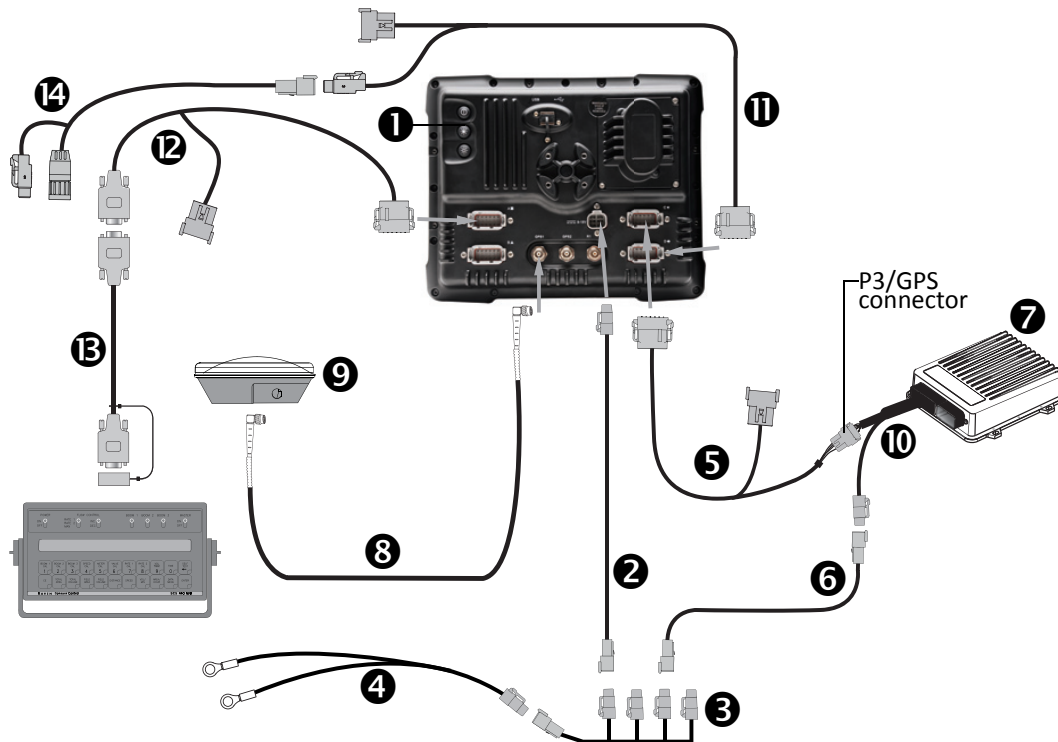

**CAUTION** – Connecting the Port Replicator on the FmX to NavController II cable ⑤ to the P4 or P12 connector of the NavController II harness ⑩ will result in damage to the FmX/FM-1000 integrated display, and will void the warranty.

Item	Description	Trimble part number
①	FmX integrated display	93100-01
②	FmX power cable	66694
③	FmX power cable with relay and switch (power bus)	67259
④	Basic power cable	67258
⑤	FmX to NavController II cable with port replicator	75741
⑥	2 pin DTM to 2 pin DT power adaptor	67095
⑦	NavController II	55563-00
⑧	8 m GPS TNC/TNC RT angle cable	50449
⑨	Ag25 GNSS antenna	77038-00
⑩	Main NavController II cable	54601
⑪	FmX universal radar adaptor	68461
⑫	FmX to DE9, RS232	67091

Item	Description	Trimble part number
③	FmX / FM-1000 / EZ-Guide 500 to Raven variable rate adaptor	69729
④	Cable, radar speed output, Raven	64272

## FmX / Autopilot / radar output / serial variable rate for Rawson

This figure shows how to connect the FmX integrated display with the Autopilot system, radar output, and serial variable rate for Rawson systems:

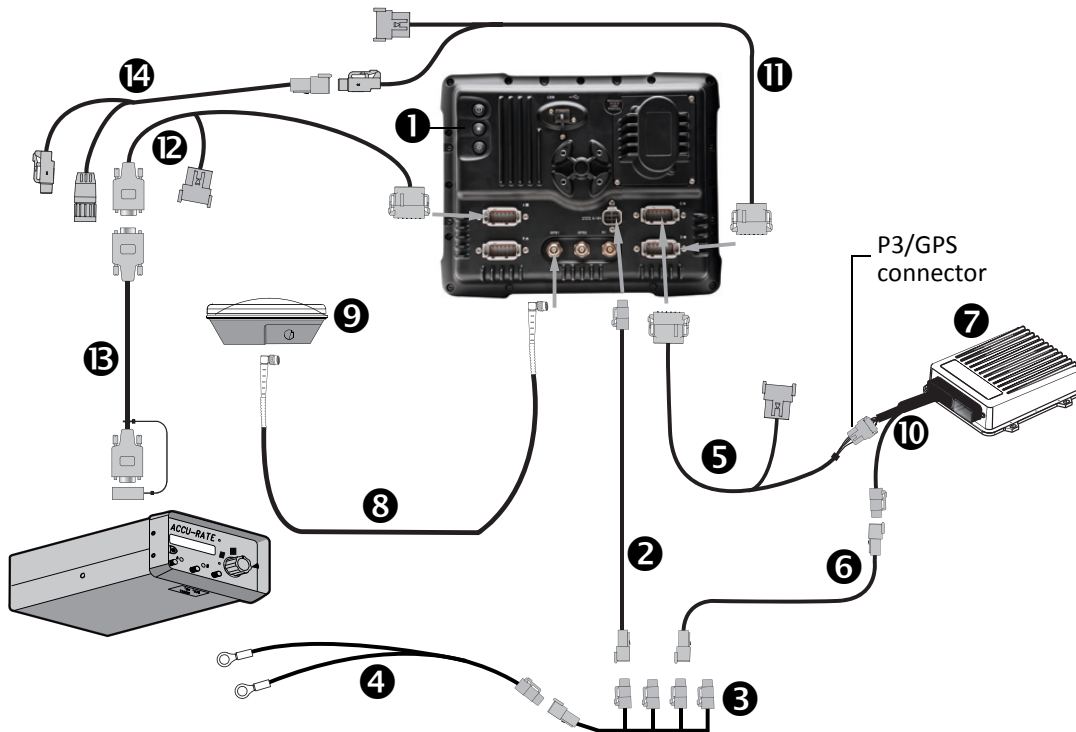

**CAUTION** – Connecting the Port Replicator on the FmX to NavController II cable ⑤ to the P4 or P12 connector of the NavController II harness ⑩ will result in damage to the FmX/FM-1000 integrated display, and will void the warranty.

Item	Description	Trimble part number
①	FmX integrated display	93100-01
②	FmX power cable	66694
③	FmX power cable with relay and switch (power bus)	67259
④	Basic power cable	67258
⑤	FmX to NavController II cable with port replicator	75741
⑥	2 pin DTM to 2 pin DT power adaptor	67095
⑦	NavController II	55563-00
⑧	8 m GPS TNC/TNC RT angle cable	50449
⑨	Ag25 GNSS antenna	77038-00
⑩	Main NavController II cable	54601
⑪	FmX universal radar adaptor	68461
⑫	FmX to DE9, RS232	67091

Item	Description	Trimble part number
③	FmX / FM-1000 / EZ-Guide 500 to Rawson variable rate adaptor	69730
④	Rawson radar speed output cable	64273

## FmX / Autopilot / radar output / serial variable rate

This figure shows how to connect the FmX integrated display with the Autopilot system, radar output, and serial variable rate for a range of third-party systems:

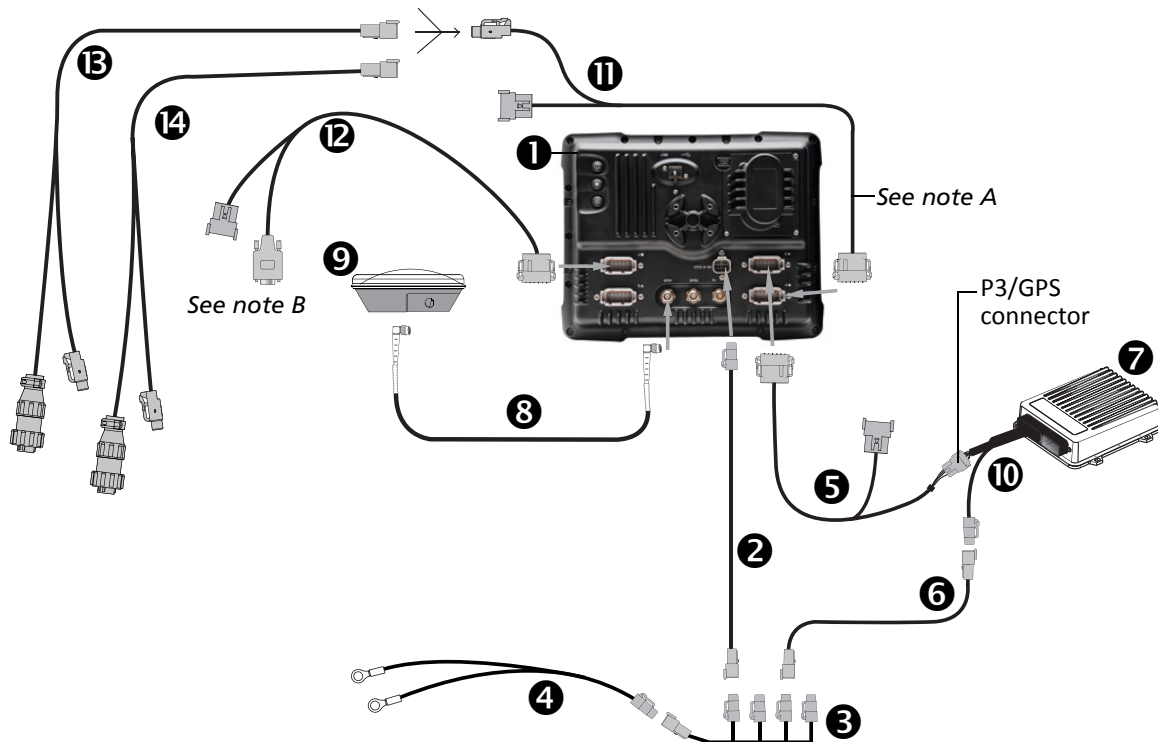

**CAUTION** – Connecting the Port Replicator on the FmX to NavController II cable ⑤ to the P4 or P12 connector of the NavController II harness ⑩ will result in damage to the FmX/FM-1000 integrated display, and will void the warranty.

*Note A* – The radar output cable must be connected to port C or D.

*Note B* – To rate controller.

Item	Description	Trimble part number
①	FmX integrated display	93100-01
②	FmX power cable	66694
③	FmX power cable with relay and switch (power bus)	67259
④	Basic power cable	67258
⑤	FmX to NavController II cable with port replicator	75741
⑥	2 pin DTM to 2 pin DT power adaptor	67095
⑦	NavController II	55563-00
⑧	8 m GPS TNC/TNC RT angle cable	50449
⑨	Ag25 GNSS antenna	77038-00
⑩	Main NavController II cable	54601
⑪	FmX universal radar adaptor	68461

Item	Description	Trimble part number
⑫	FmX to DE9, RS232	67091
⑬	Cable, radar speed output, DICKEY-john	64273
⑭	Cable, radar speed output, Hiniker	64274

## FmX / Autopilot / serial connection for Hardi 5500 controller

This figure shows how to connect the FmX integrated display with the Autopilot system, radar output, and serial variable rate for a Hardi 5500 controller:

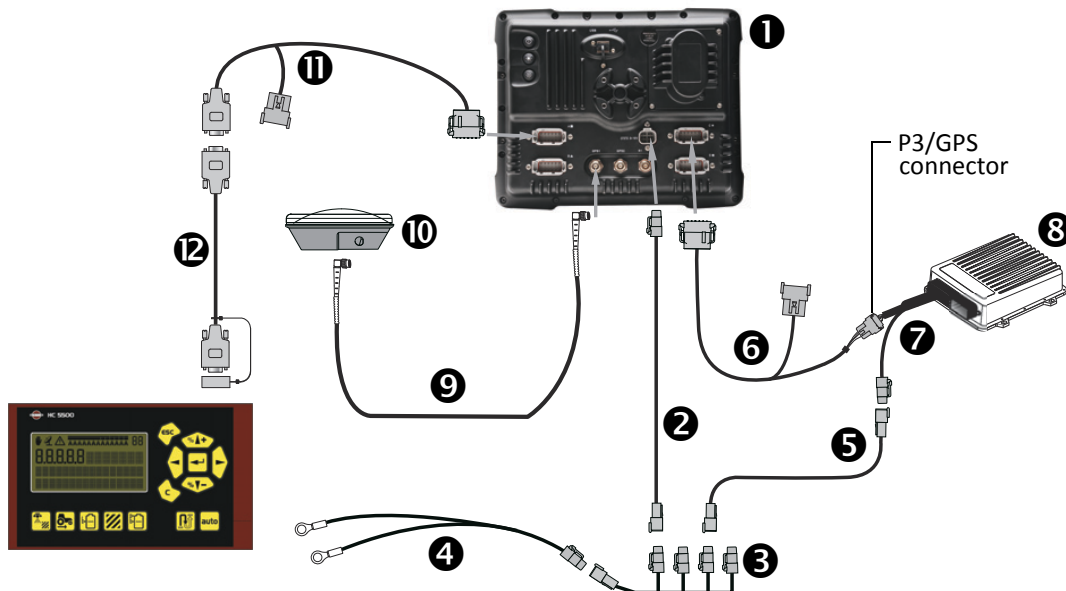

**CAUTION** – Connecting the Port Replicator on the FmX to NavController II cable ⑥ to the P4 or P12 connector of the NavController II harness ⑦ will result in damage to the FmX/FM-1000 integrated display, and will void the warranty.

*Note* – For the Hardi 5500 controller to work with the FmX integrated display, it must have firmware version 3.16 or greater installed and have a JOBCOM control box connected.

Item	Description	Trimble part number
①	FmX integrated display	93100-01
②	FmX power cable	66694
③	FmX power cable with relay and switch (power bus)	67259
④	Basic power cable	67258
⑤	2 pin DTM to 2 pin DT power adaptor	67095
⑥	FmX to NavController II cable with port replicator	75741
⑦	Main NavController II cable	54601
⑧	NavController II	55563-00
⑨	8 m GPS TNC/TNC RT angle cable	50449
⑩	Ag25 GNSS antenna	77038-00
⑪	FmX to DE9, RS232	67091
⑫	DB9(F) to DB9(F) null modem cable	59043

# Connecting to the Tru Application Control System

## In this chapter:

- Manual guidance FmX / Tru Application Control
- FmX / Autopilot / Tru Application Control / RTK corrections
- FmX / Autopilot / Tru Application Control / TrueTracker / RTK corrections

This chapter shows the different ways to connect the FmX integrated display to the Tru Application Control™ system.



---

**CAUTION** – Connecting the Port Replicator on the FmX display to the NavController II cable to the P4 or P12 connector of the NavController II harness will result in damage to the FmX / FM-1000 integrated display, and will void the warranty.

---

## Manual guidance FmX / Tru Application Control

This figure shows how to connect the FmX integrated display with the Tru Application Control system, while using manual guidance:

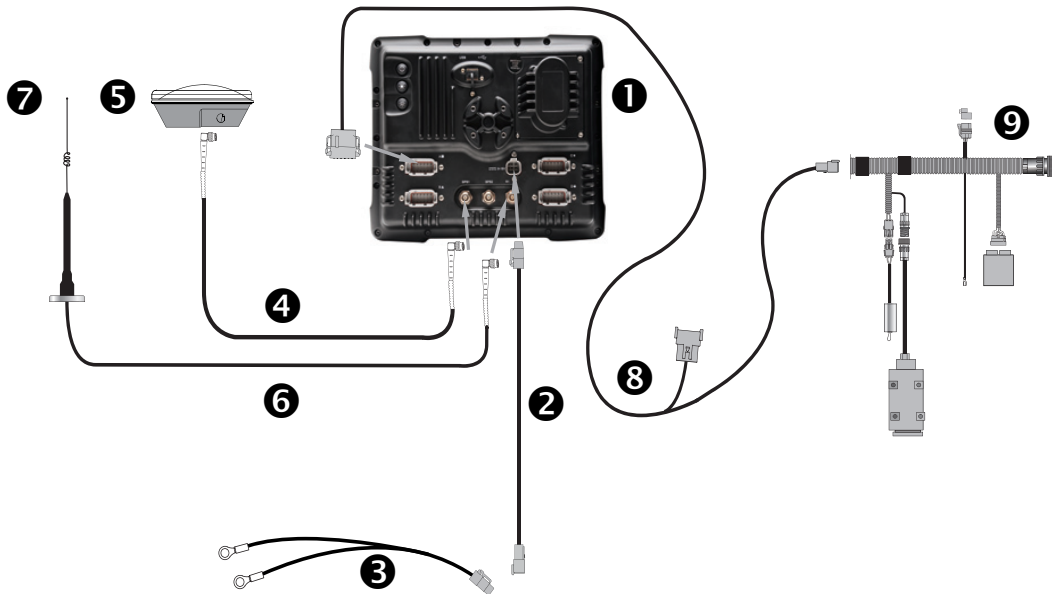

Item	Description	Trimble part number
1	FmX integrated display	93100-02
2	FmX power cable	66694
3	FmX basic power cable	67258
4	8 m GPS TNC/TNC RT angle cable	50449
5	Ag25 GNSS antenna	77038-00
6	NMO to TNC 20ft antenna cable and base	62120
7	900 MHz radio antenna kit	22882-10
8	FmX to CAN cable with port replicator	75407
9	Application Control cab harness cable	64909

## FmX / Autopilot / Tru Application Control / RTK corrections

This figure shows how to connect the FmX integrated display with the Autopilot system and the Tru Application Control system, to use RTK corrections:

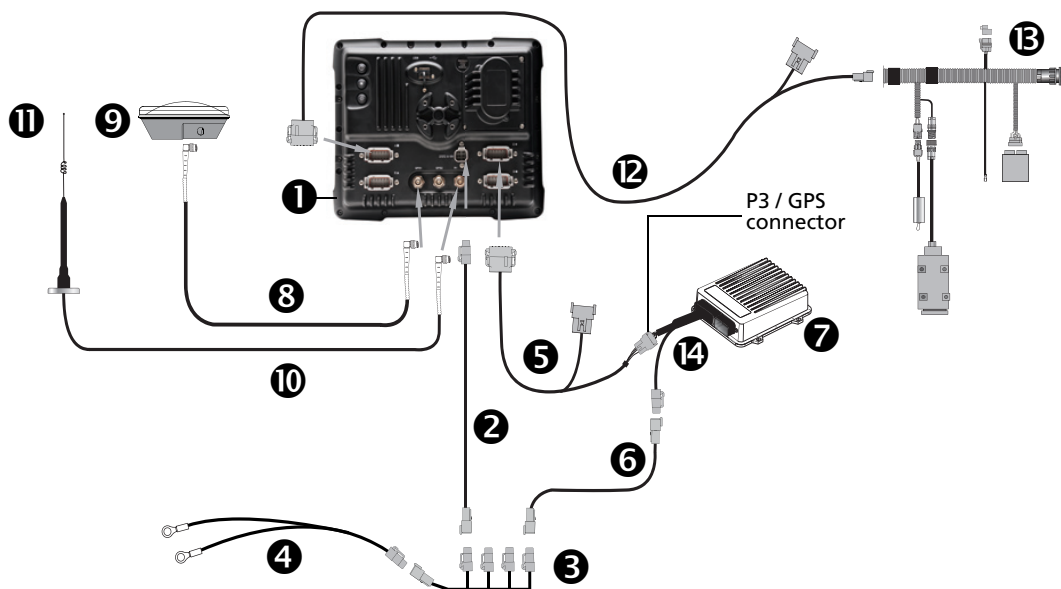

**CAUTION** – Connecting the Port Replicator on the FmX to NavController II cable 5 to the P4 or P12 connector of the NavController II harness 14 will result in damage to the FmX/FM-1000 integrated display, and will void the warranty.

Item	Description	Trimble part number
1	FmX integrated display	93100-02
2	FmX power cable	66694
3	FmX power cable with relay and switch (power bus)	67259
4	Basic power cable	67258
5	FmX to NavController II cable with port replicator	75741
6	2 pin DTM to 2 pin DT power adaptor	67095
7	NavController II	55563-00
8	8 m GPS TNC/TNC RT angle cable	50449
9	Ag25 GNSS antenna	77038-00
10	NMO to TNC 20ft antenna cable and base	62120
11	900 MHz radio antenna kit	22882-10
12	FmX to CAN cable with port replicator	75407
13	Tru Application Control cab harness cable	64909
14	Main NavController II cable	54601

## FmX / Autopilot / Tru Application Control / TrueTracker / RTK corrections

This figure shows how to connect the FmX integrated display with the Autopilot system, Tru Application Control, and TrueTracker system, to use RTK corrections:

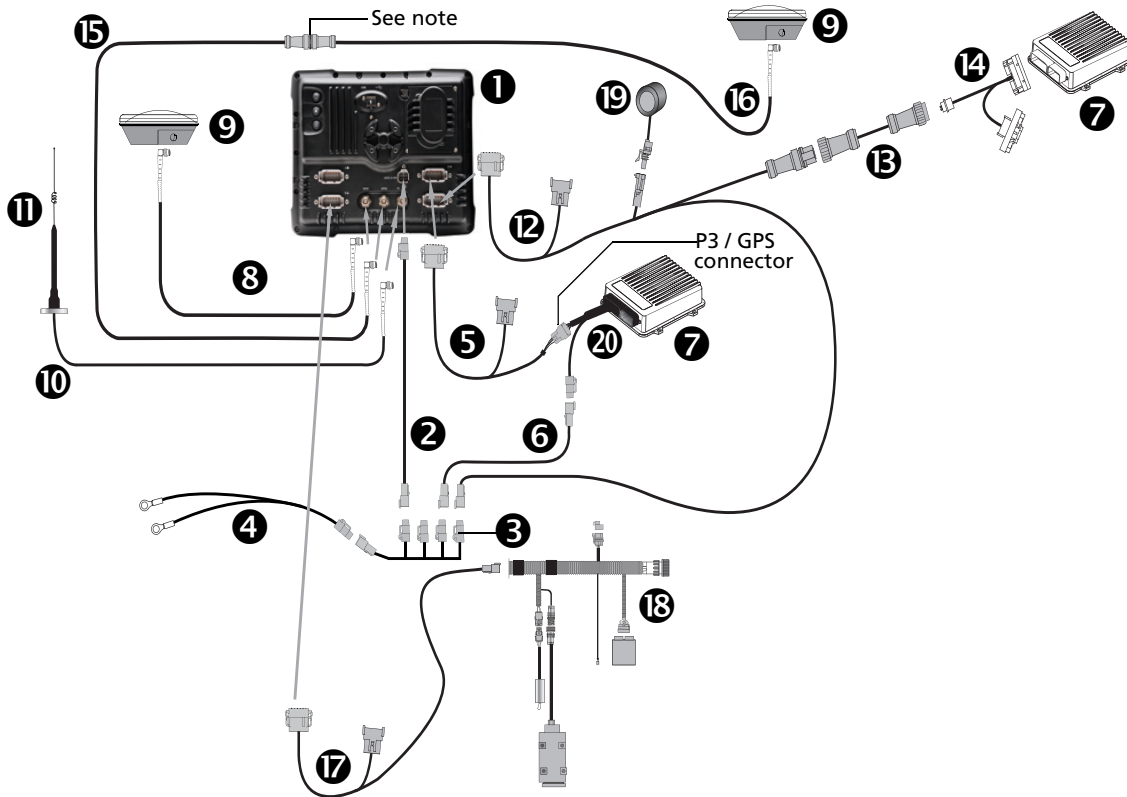

**CAUTION** – Connecting the Port Replicator on the FmX to NavController II cable ⑤ to the P4 or P12 connector of the NavController II harness ⑳ will result in damage to the FmX/FM-1000 integrated display, and will void the warranty.

**Note** – An optional LMR400 65' extension cable (P/N 67473) is available for implements with a long tongue.

Item	Description	Trimble part number
①	FmX integrated display	93100-02
②	FmX power cable	66694
③	FmX power cable with relay and switch (power bus)	67259
④	Basic power cable	67258
⑤	FmX to NavController II cable with port replicator	75741
⑥	2 pin DTM to 2 pin DT power adaptor	67095
⑦	NavController II (x2)	55563-00
⑧	8 m GPS TNC/TNC RT angle cable	50449
⑨	Ag25 GNSS antenna	77038-00

Item	Description	Trimble part number
⑩	NMO to TNC 20ft antenna cable and base	62120
⑪	900 MHz radio antenna kit	22882-10
⑫	FmX to TrueTracker cable	67092
⑬	Implement 10-pin data cable	0793-8740-450
⑭	FmX to NavController II and TrueTracker main harness	67612
⑮	Coaxial 160" N/f + TNC/m-ra cable	68295
⑯	Coaxial 480" N/m + TNC/m-ra cable	67472
⑰	FmX to CAN cable with port replicator	75407
⑱	Tru Application Control cab harness	64909
⑲	Sonalert	43104
⑳	Main NavController II cable	54601

# Connecting External Receivers, Radios, and Modems

## In this chapter:

- FmX / Autopilot / AgGPS 252/262
- FmX / TrueGuide or Implement Monitoring with an AgGPS 252/262 external receiver
- FmX / Autopilot / External receiver for Implement Monitoring, TrueGuide, or FieldLevel II
- FmX / Autopilot / Ag3000 VRS corrections
- FmX / Autopilot / Sierra wireless modem
- FmX / Autopilot / DCM-300

This chapter shows the different ways to connect the FmX integrated display to external receivers.



---

**CAUTION** – Connecting the Port Replicator on the FmX display to the NavController II cable to the P4 or P12 connector of the NavController II harness will result in damage to the FmX / FM-1000 integrated display, and will void the warranty.

---

## FmX / Autopilot / AgGPS 252/262

This figure shows how to connect the FmX integrated display with the Autopilot system, while using an AgGPS 252 or an AgGPS 262 receiver:

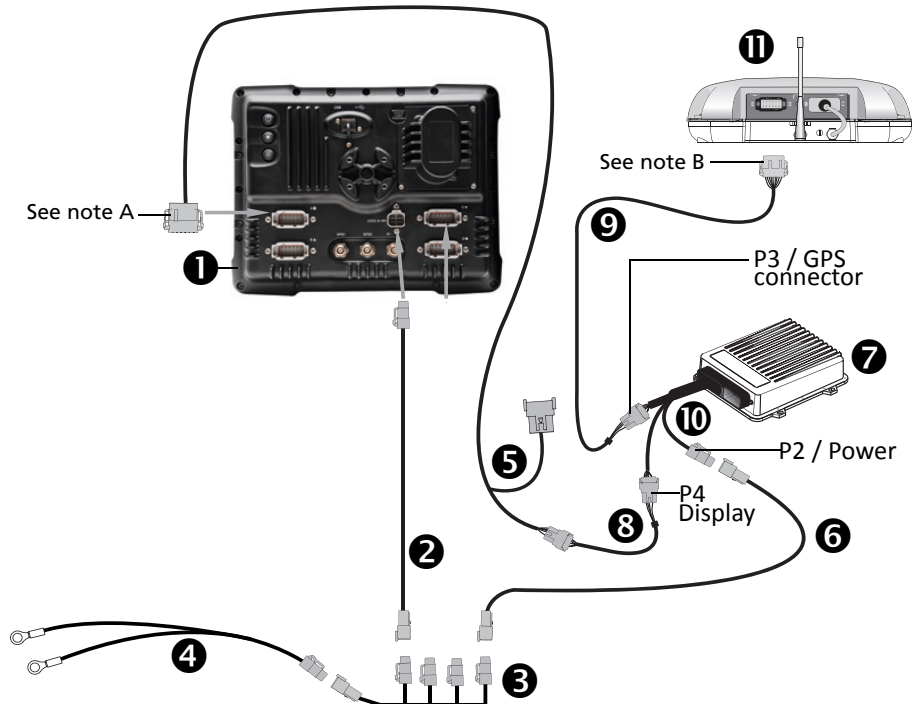

**CAUTION** – Connecting the Port Replicator on the FmX to NavController II cable 5 to the P4 or P12 connector of the NavController II harness 10 will result in damage to the FmX/FM-1000 integrated display, and will void the warranty.

**Note** – Connect to port A or port B.

**Note** – Connect to port “A” only.

Item	Description	Trimble part number
1	FmX integrated display	93100-01
2	FmX power cable	66694
3	FmX power cable with relay and switch (power bus)	67259
4	Basic power cable	67258
5	FmX to NavController II cable with port replicator	75741
6	2 pin DTM to 2 pin DT power adaptor	67095
7	NavController II	55563-00
8	Cable assembly, 8-pin to 12-pin adaptor	76442
9	Cable, AgGPS 252/252 to NavController II	54608
10	Main NavController II cable	54601
11	AgGPS 252/262 receiver	55500-xx

## FmX / TrueGuide or Implement Monitoring with an AgGPS 252/262 external receiver

This figure shows how to connect the FmX integrated display with the Autopilot system and TrueGuide system, while using a second external receiver with RTK corrections:

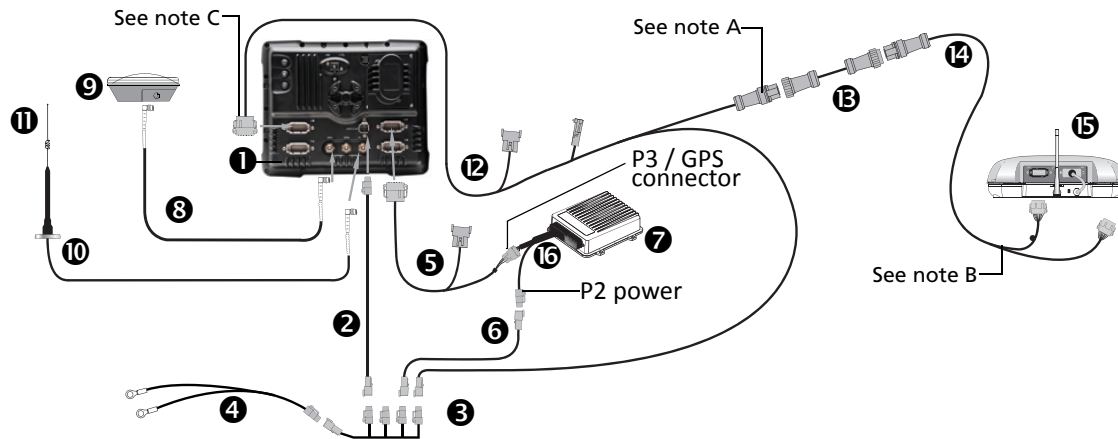

**CAUTION** – Connecting the Port Replicator on the FmX to NavController II cable ⑤ to the P4 or P12 connector of the NavController II harness ⑬ will result in damage to the FmX/FM-1000 integrated display, and will void the warranty.

**Note** – An optional 45' 10-pin data extension cable (P/N AG\_0793-1290-450) is available for implements with a long tongue.

**Note** – Connect to port “A” only.

**Note** – Connect to port “A” or port “B”.

Item	Description	Trimble part number
①	FmX integrated display	93100-02
②	FmX power cable	66694
③	FmX power cable with relay and switch (power bus)	67259
④	Basic power cable	67258
⑤	FmX to NavController II cable with port replicator	75741
⑥	2 pin DTM to 2 pin DT power adaptor	67095
⑦	NavController II	55563-00
⑧	8 m GPS TNC/TNC RT angle cable	50449
⑨	Ag25 GNSS antenna	77038-00
⑩	NMO to TNC 20 ft antenna cable and base	62120
⑪	900 MHz radio antenna kit	22882-10
⑫	FmX to TrueTracker cable	67092
⑬	Implement extension cable	0793-8740-450
⑭	Cable assembly, implement receiver extension	75447

Item	Description	Trimble part number
⑤	AgGPS 252/262 receiver	55500-xx
⑥	Main NavController II cable	54601
⑦	Sonalert	43104

## FmX / Autopilot / External receiver for Implement Monitoring, TrueGuide, or FieldLevel II

This figure shows how to connect the FmX integrated display with the Autopilot system, and external receivers (such as an Ag332 or Ag442), for use with implement monitoring, TrueGuide, or Field Level II.

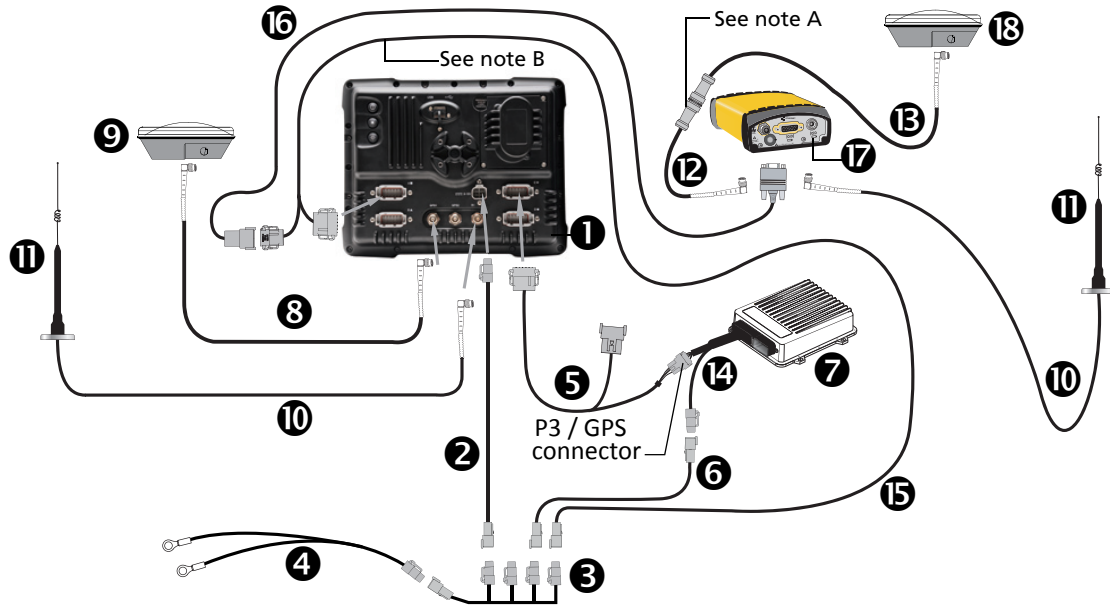

**CAUTION** – Connecting the Port Replicator on the FmX to NavController II cable 5 to the P4 or P12 connector of the NavController II harness 14 will result in damage to the FmX/FM-1000 integrated display, and will void the warranty.

**Note** – An optional LMR400 65' extension cable (P/N 67473) is available for implements with a long tongue.

**Note** – The receiver adaptor cable 15 must be connected to either port “A” or port “B”.

Item	Description	Trimble part number
1	FmX integrated display	93100-02
2	FmX power cable	66694
3	FmX power cable with relay and switch (power bus)	67259
4	Basic power cable	67258
5	FmX to NavController II cable with port replicator	75741
6	2 pin DTM to 2 pin DT power adaptor	67095
7	NavController II	55563-00
8	8 m GPS TNC/TNC RT angle cable (x2)	50449
9	Ag25 GNSS antenna	77038-00
10	NMO to TNC 20ft antenna cable and base (x2)	62120
11	900 MHz radio antenna kit (x2)	22882-10

Item	Description	Trimble part number
⑫	Coaxial 160" N/f + TNC/m-ra cable	68295
⑬	Coaxial 480" N/m + TNC/m-ra cable	67472
⑭	Main NavController II cable	54601
⑮	FmX to external receiver adaptor cable	71453
⑯	AgGPS 442 receiver cable	62037
⑰	AgGPS 442 receiver	
⑱	Zephyr model 2 antenna	57970-00

## FmX / Autopilot / Ag3000 VRS corrections

This figure shows how to connect the FmX integrated display with the Autopilot system while using corrections from the Ag3000 modem.

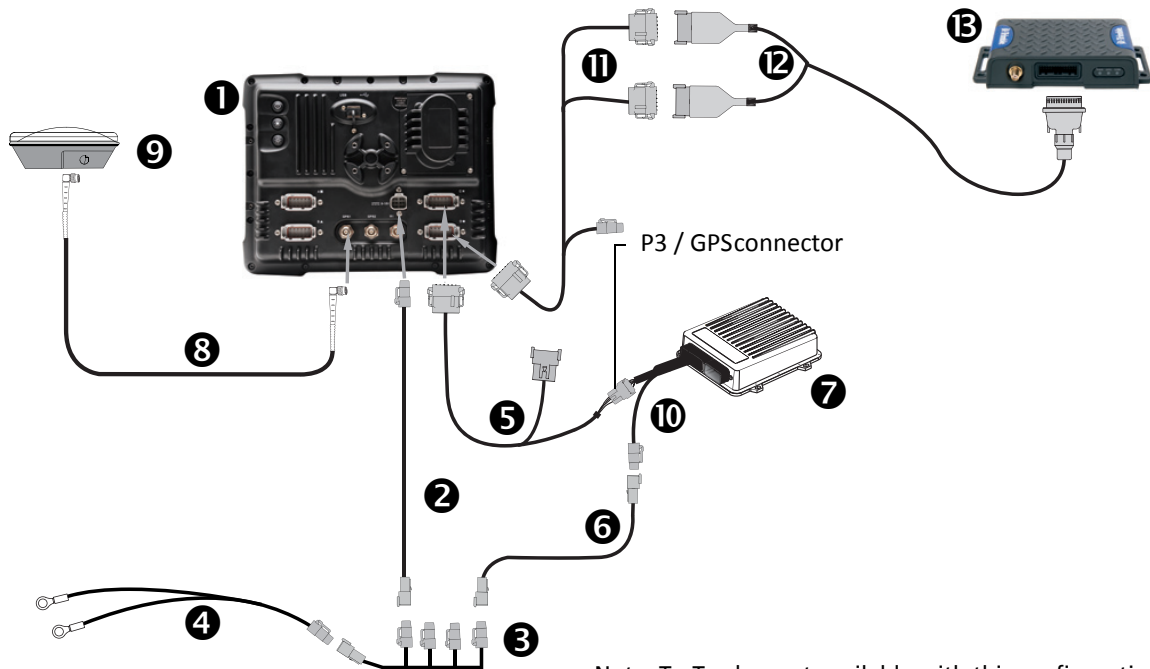

Note: TruTracker not available with this configuration



**CAUTION** – Connecting the Port Replicator on the FmX to NavController II cable 5 to the P4 or P12 connector of the NavController II harness 10 will result in damage to the FmX/FM-1000 integrated display, and will void the warranty.

Item	Description	Trimble part number
1	FmX integrated display	93100-01
2	FmX power cable	66694
3	FmX power cable with relay and switch (power bus)	67259
4	Basic power cable	67258
5	FmX to NavController II cable with port replicator	75741
6	2 pin DTM to 2 pin DT power adaptor	67095
7	NavController II	55563-00
8	8m GPS TNC/TNC RT angle cable	76442
9	Ag25 GNSS antenna	77038-00
10	Main NavController II cable	54601
11	Ag3000 to FmX/FM-1000 cable	77273
12	Ag3000 break-out cable	70433
13	Ag3000 modem	80300

## FmX / Autopilot / Sierra wireless modem

Connecting the FmX integrated display with the Autopilot system and the Sierra wireless modem:

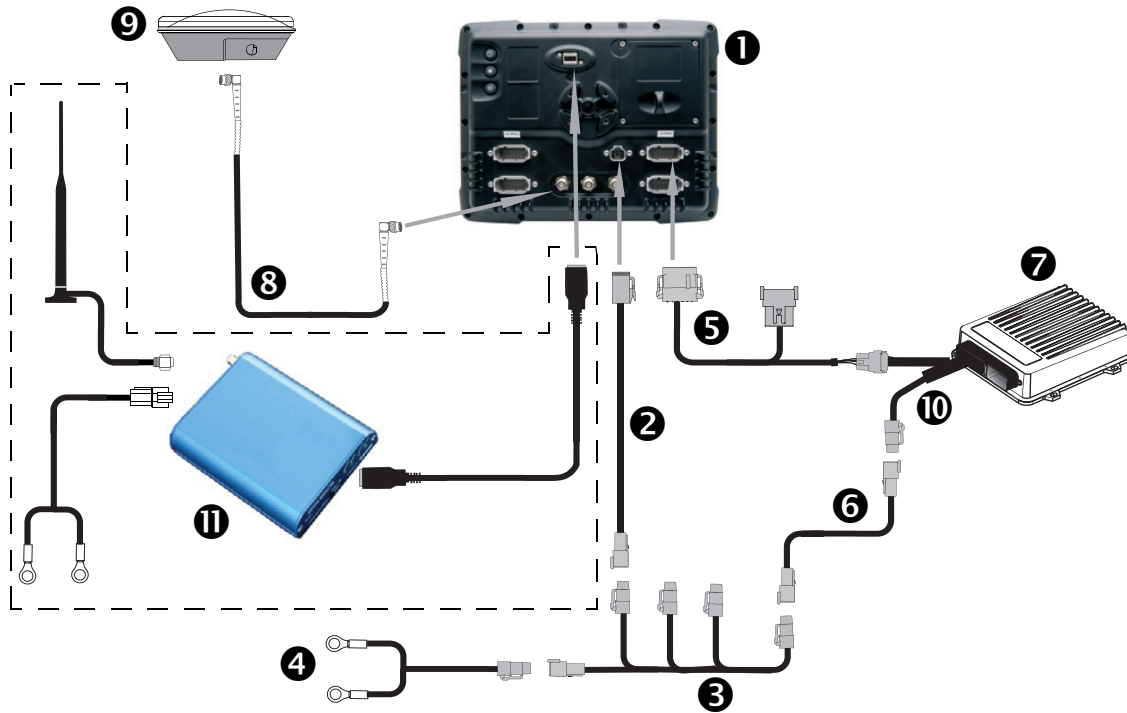

**CAUTION** – Connecting the Port Replicator on the FmX / FM-1000 display to NavController II cable 5 to the P4 or P12 connector of the NavController II harness 10 will result in damage to the display and will void the warranty.

Item	Description	Trimble part number
1	FmX integrated display	93100-01
2	FmX power cable	66694
3	FmX power cable with relay and switch (power bus)	67259
4	Basic power cable	67258
5	FmX to NavController II cable with port replicator	75741
6	2 pin DTM to 2 pin DT power adaptor	67095
7	NavController II	55563-00
8	8m GPS TNC/TNC RT angle cable	76442
9	Ag25 GNSS antenna	77038-00
10	Main NavController II cable	54601
11	Sierra Wireless Modem kit: <ul style="list-style-type: none"> <li>• Antenna</li> <li>• Mag mount base</li> <li>• USB cable</li> </ul> <i>Note – Part number dependant on wireless provider.</i>	71116-xx

## FmX / Autopilot / DCM-300

Connecting the FmX integrated display with the Autopilot system and the DCM-300 wireless modem:

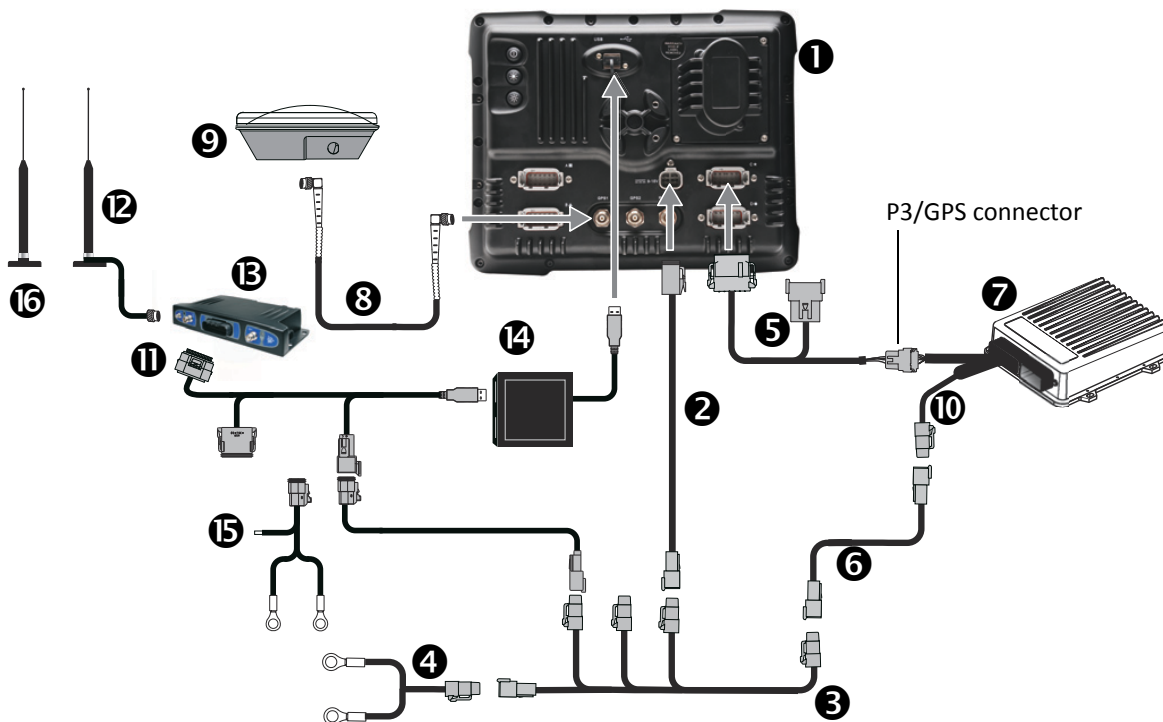

**CAUTION** – Connecting the Port Replicator on the FmX / FM-1000 to NavController II cable 5 to the P4 or P12 connector of the NavController II harness 10 will result in damage to the display and will void the warranty.

Item	Description	Trimble part number
1	FmX integrated display	93100-01
2	FmX power cable	66694
3	FmX power cable with relay and switch (power bus)	67259
4	Basic power cable	67258
5	FmX to NavController II cable with port replicator	75741
6	2 pin DTM to 2 pin DT power adaptor	67095
7	NavController II	55563-00
8	8m GPS TNC/TNC RT angle cable	76442
9	Ag25 GNSS antenna	77038-00
10	Main NavController II cable	54601
11	DCM-300 to display cable	82026
12	DCM-300 cellular antenna	72122 + 51227
13	DCM-300 modem	80632-xx

Item	Description	Trimble part number
⑭	USB hub <i>Note – Must be used.</i>	82026
⑮	DCM-300 power harness: Use either the powerbus or direct power leads harness.	82026
⑯	DCM-300 wireless antenna	83700-05

# Connecting the Yield Monitoring System

## In this chapter:

- FmX / AgLeader YM2000 yield monitoring system
- FmX / John Deere 9x60 / 9x70 yield monitoring system

This chapter shows the different ways to connect the FmX integrated display to a Yield Monitoring system.



---

**CAUTION** – Connecting the Port Replicator on the FmX display to the NavController II cable to the P4 or P12 connector of the NavController II harness will result in damage to the FmX / FM-1000 integrated display, and will void the warranty.

---

## FmX / AgLeader YM2000 yield monitoring system

This figure shows how to connect the FmX integrated display to the AgLeader YM 2000 yield monitoring system:

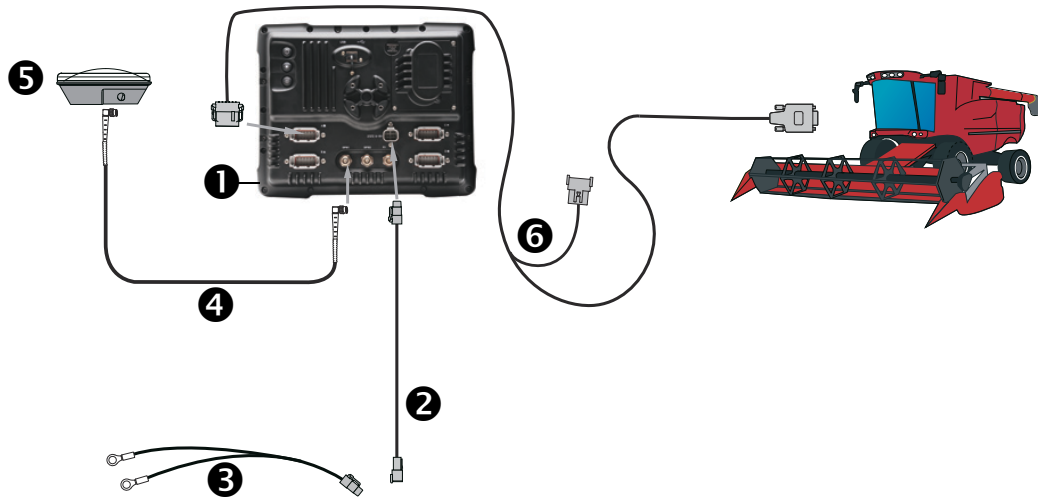

Item	Description	Trimble part number
1	FmX integrated display	93100-01
2	FmX power cable	66694
3	FmX basic power cable	67258
4	8 m GPS TNC/TNC RT angle cable	50449
5	Ag25 GNSS antenna	77038-00
6	Display to DE9 RS232 cable	67091

## FmX / John Deere 9x60 / 9x70 yield monitoring system

This figure shows how to connect the FmX integrated display to the John Deere 9x60 or 9x70 yield monitoring system:

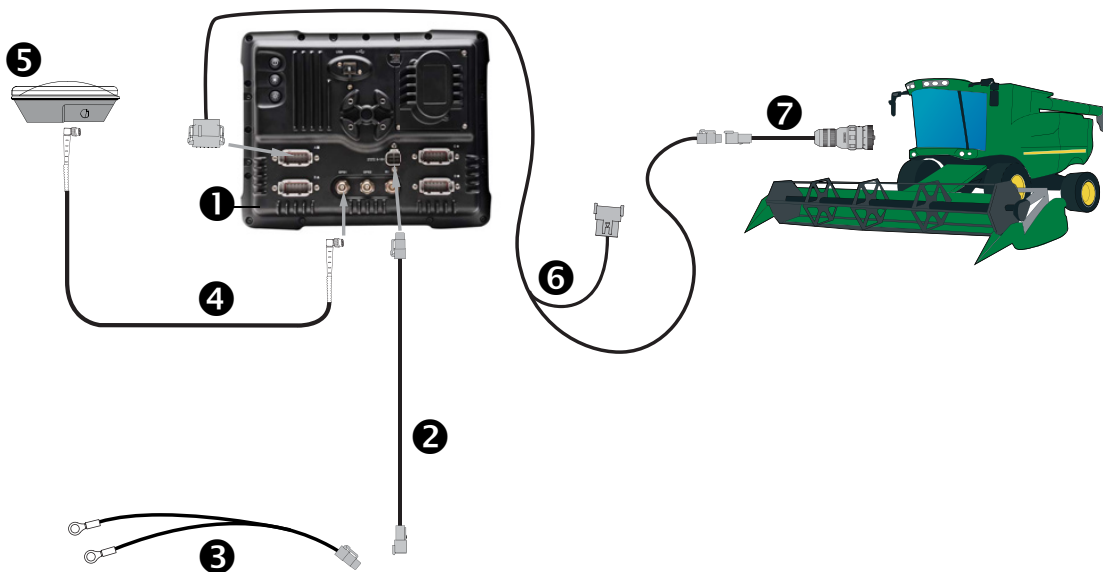

**Note** – Connect only to port A on the FmX integrated display; when using yield monitoring do not connect another CAN device to the occupied port.

Item	Description	Trimble part number
1	FmX integrated display	93100-01
2	FmX power cable	66694
3	FmX basic power cable	67258
4	8 m GPS TNC/TNC RT angle cable	50449
5	Ag25 GNSS antenna	77038-00
6	FmX to CAN cable with port replicator	75407
7	Display to John Deere 9x70, or 9x60 non-ATR Display to John Deere 9x60 ATR	76509 77692

## FmX / Yield Monitoring system

This figure shows how to connect the FmX integrated display to the Yield Monitoring system:

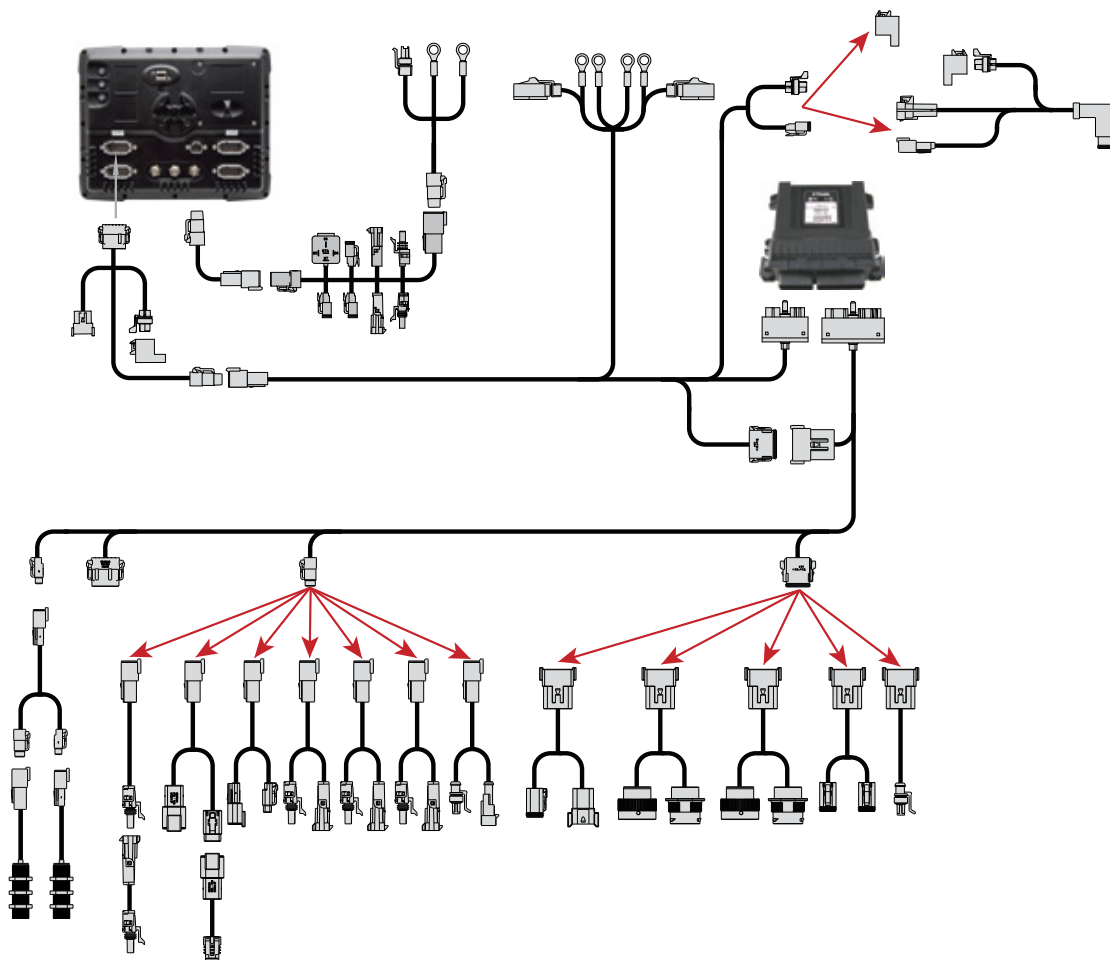

Item	Description	Trimble part number
❶	FmX integrated display	93100-01
❷	FmX power cable	66694
❸	FmX basic power cable	67258
❹	8 m GPS TNC/TNC RT angle cable	50449
❺	Ag25 GNSS antenna	77038-00
❻	FmX to CAN cable with port replicator	75407
❼	Display to John Deere 9x70, or 9x60 non-ATR Display to John Deere 9x60 ATR	76509 77692

# Connecting the WM-Drain Solution

## In this chapter:

- [FmX / Water Management cabling](#)
- [FmX / WM-Drain / IMD-600](#)

This chapter shows how to connect the FmX integrated display to the WM-Drain™ solution.

# FmX / Water Management cabling

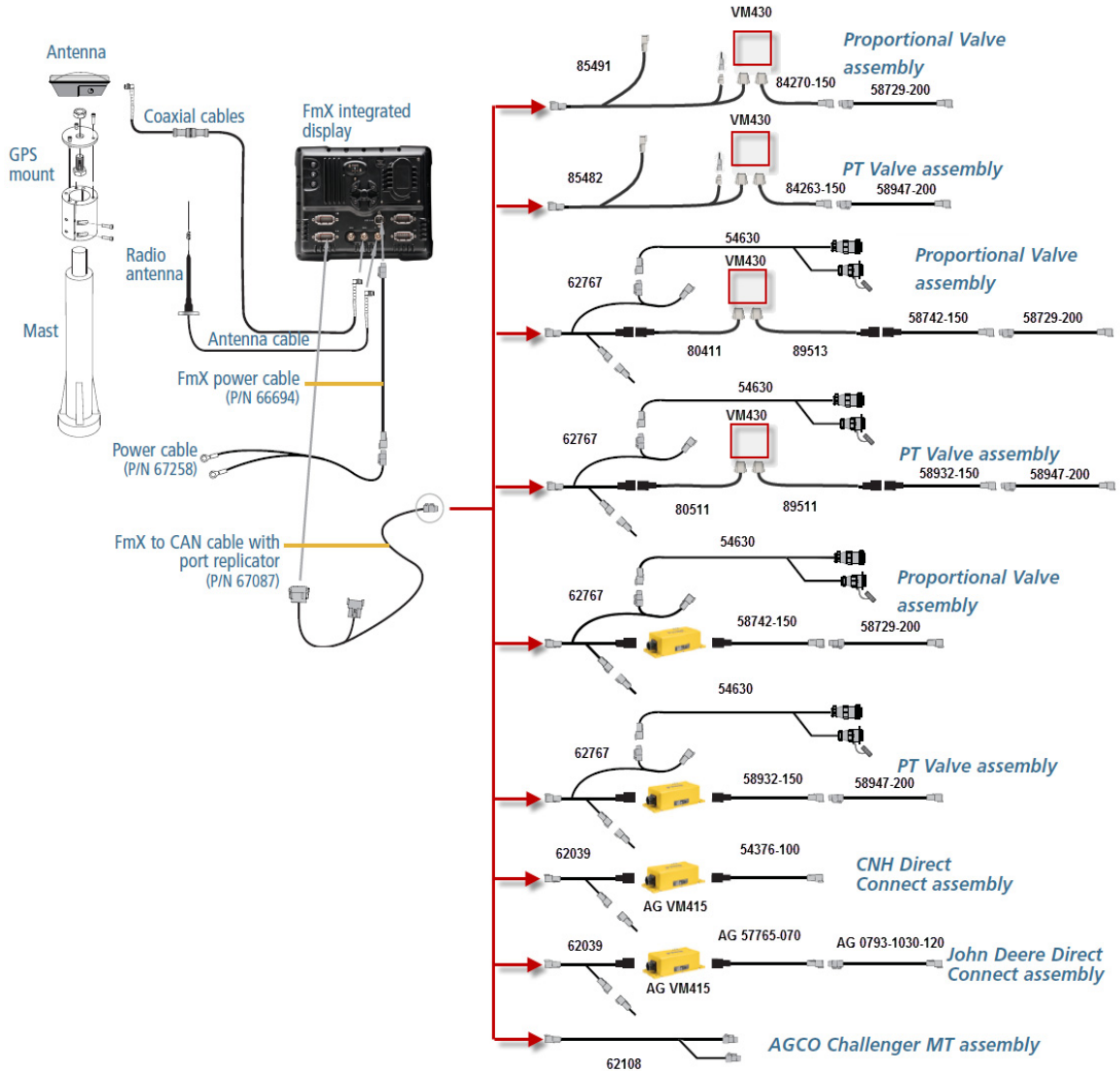

## FmX / WM-Drain / IMD-600

Connecting the FmX integrated display with the WM-Drain solution and IMD-600 unit:

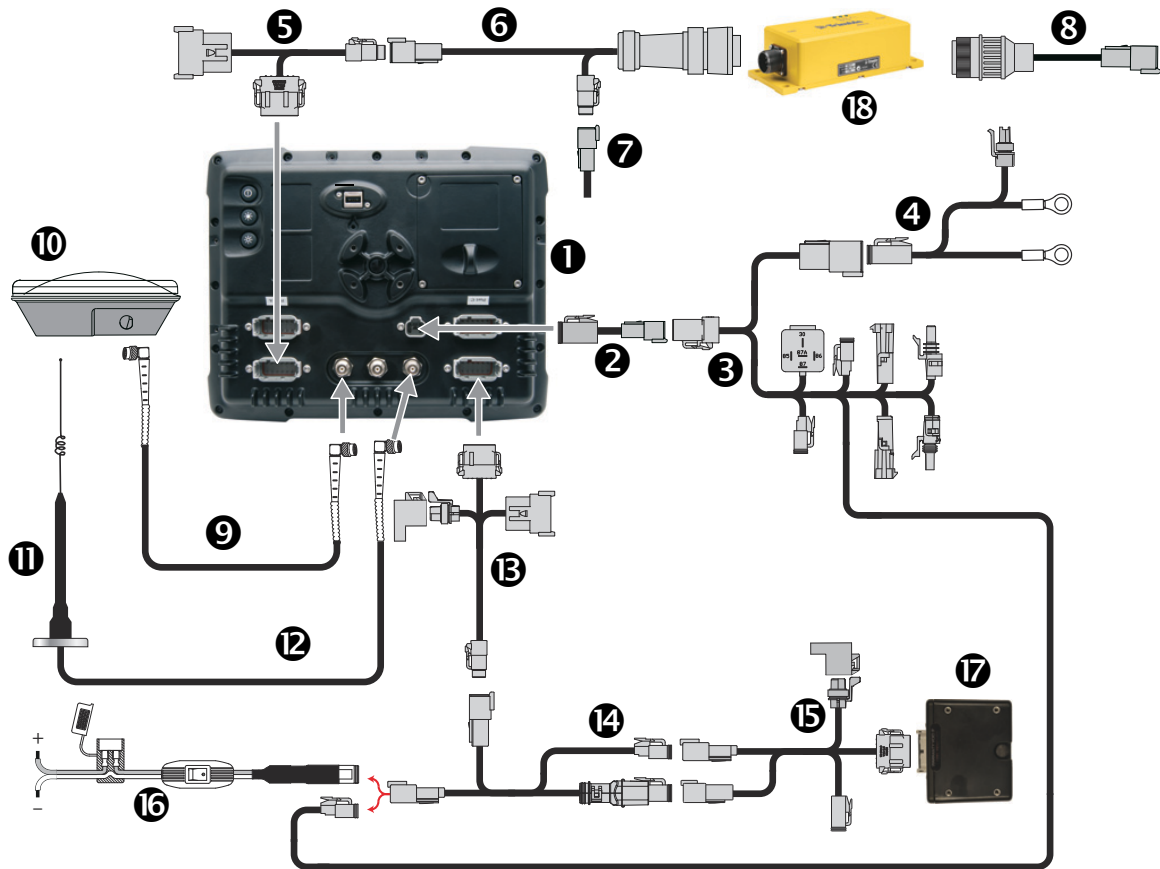

Item	Description	Trimble part number
①	FmX integrated display	93100-01
②	FmX power cable	66694
③	Cable Assy, FmX power with relay and switch	67259
④	FmX basic power cable	67258
⑤	FmX to CAN cable with port replicator	75407
⑥	CAN to VM and FieldLevel II cable	62039
⑦	CAN terminator	59783
⑧	Cable Assy, VLV VM415 DUAL CASE DIRCET	54376-100
⑨	8 m GPS TNC/TNC RT angle cable	50449
⑩	Ag25 GNSS antenna	77038-00
⑪	Antenna kit, radio, Sitenet 900, 0db/3db/5db with base	22882-10
⑫	Antenna cable, magnetic base NMO-TO-TNC	62120
⑬	Cable Assy, FmX to Field-IQ	75834
⑭	Cable Assy, CAN CAB to Hitch, Field-IQ	77368
⑮	Cable Assy, IMD-600 Adapter	85789

Item	Description	Trimble part number
⑥	Cable Assy, Cord Set w/1LFH and Deutsch Plug Connector <sup>1</sup>	75743
⑦	IMD-600 unit	833901-01
⑧	Ag VM415	VM415

<sup>1</sup>Note - If you do not use the power bus (P/N 67259), you can plug the unterminated power cable (P/N 75743) into the switch cable (P/N 77368).

# Connecting to the FieldLevel II System

## In this chapter:

- FmX / Autopilot / FieldLevel II / AGCO Challenger MT / RTK corrections
- FmX / Autopilot / FieldLevel II / CNH direct connect / RTK corrections
- FmX / Autopilot / FieldLevel II / John Deere direct-connect / RTK corrections
- FmX / Autopilot / FieldLevel II / Proportional valve / RTK corrections
- FmX / Autopilot / FieldLevel II / PT valve / RTK corrections
- FmX / FieldLevel II / Tandem or dual antenna / RTK corrections
- FmX / Autopilot / AgGPS 252/262 / FieldLevel II / Tandem or dual antenna / RTK corrections
- FmX / FieldLevel II / Without power bus

This chapter shows the different ways to connect the FmX integrated display to the FieldLevel II system.



---

**CAUTION** – Connecting the Port Replicator on the FmX display to the NavController II cable to the P4 or P12 connector of the NavController II harness will result in damage to the FmX / FM-1000 integrated display, and will void the warranty.

---

# FmX / Autopilot / FieldLevel II / AGCO Challenger MT / RTK corrections

This figure shows how to connect the FmX integrated display with the Autopilot automated steering system, and the FieldLevel II system on AGCO Challenger MT tractors:

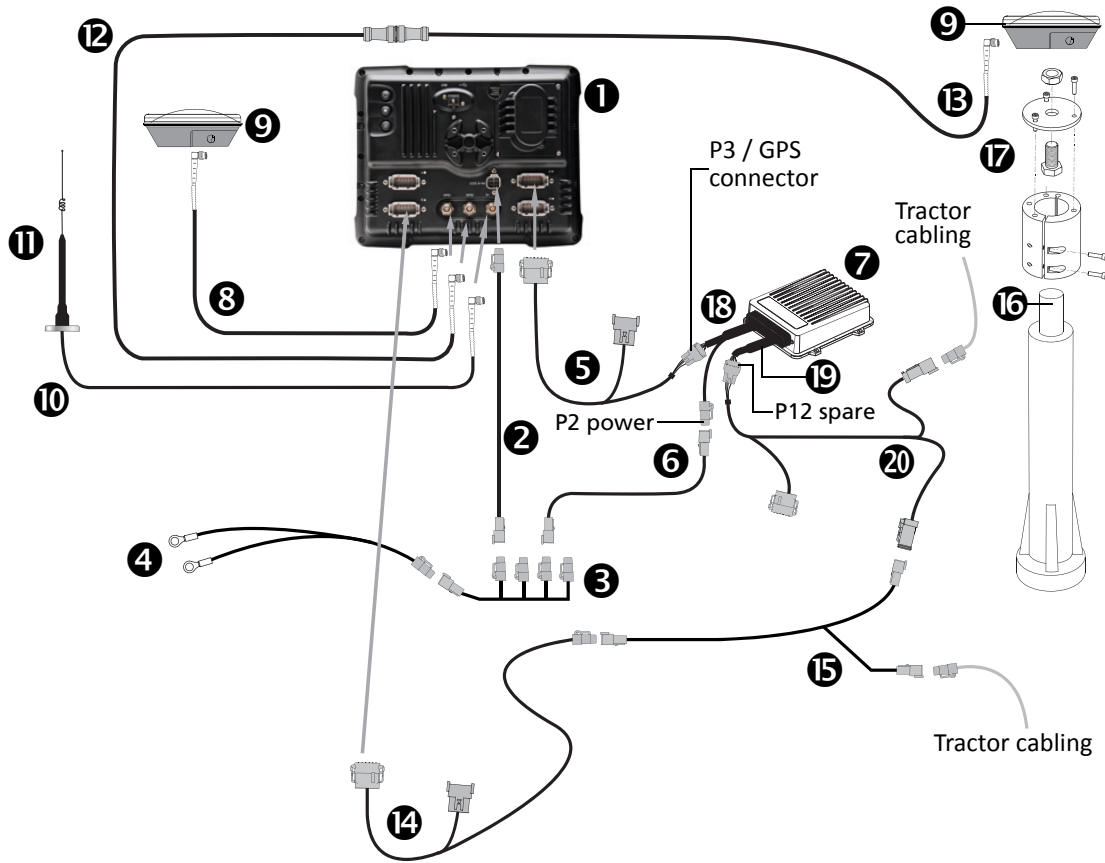

**CAUTION** – Connecting the Port Replicator on the FmX to NavController II cable 5 to the P4 or P12 connector of the NavController II harness 18 will result in damage to the FmX/FM-1000 integrated display, and will void the warranty.

Item	Description	Trimble part number
1	FmX integrated display	93100-02
2	FmX power cable	66694
3	FmX power cable with relay and switch (power bus)	67259
4	Basic power cable	67258
5	FmX to NavController II cable with port replicator	75741
6	2 pin DTM to 2 pin DT power adaptor	67095
7	NavController II	55563-00
8	8 m GPS TNC/TNC RT angle cable	50449
9	Ag25 GNSS antenna	77038-00

Item	Description	Trimble part number
⑩	NMO to TNC 20ft antenna cable and base	62120
⑪	900 MHz radio antenna kit	22882-10
⑫	Coaxial 160" N/f + TNC/m-ra cable	68295
⑬	Coaxial 480" N/m + TNC/m-ra cable	67472
⑭	FmX to CAN cable with port replicator	75407
⑮	Challenger MT CAN interface - FieldLevel II	62108
⑯	Mast	MM2E-T
⑰	GPS mount	0367-3440
⑱	Main NavController II cable	54601
⑲	Auxiliary NavController II cable	54602
⑳	Challenger MT CAN interface to Autopilot cable	56850

## FmX / Autopilot / FieldLevel II / CNH direct connect / RTK corrections

This figure shows how to connect the FmX integrated display with the Autopilot automated steering system, and the FieldLevel II system on CNH direct-connect machines:

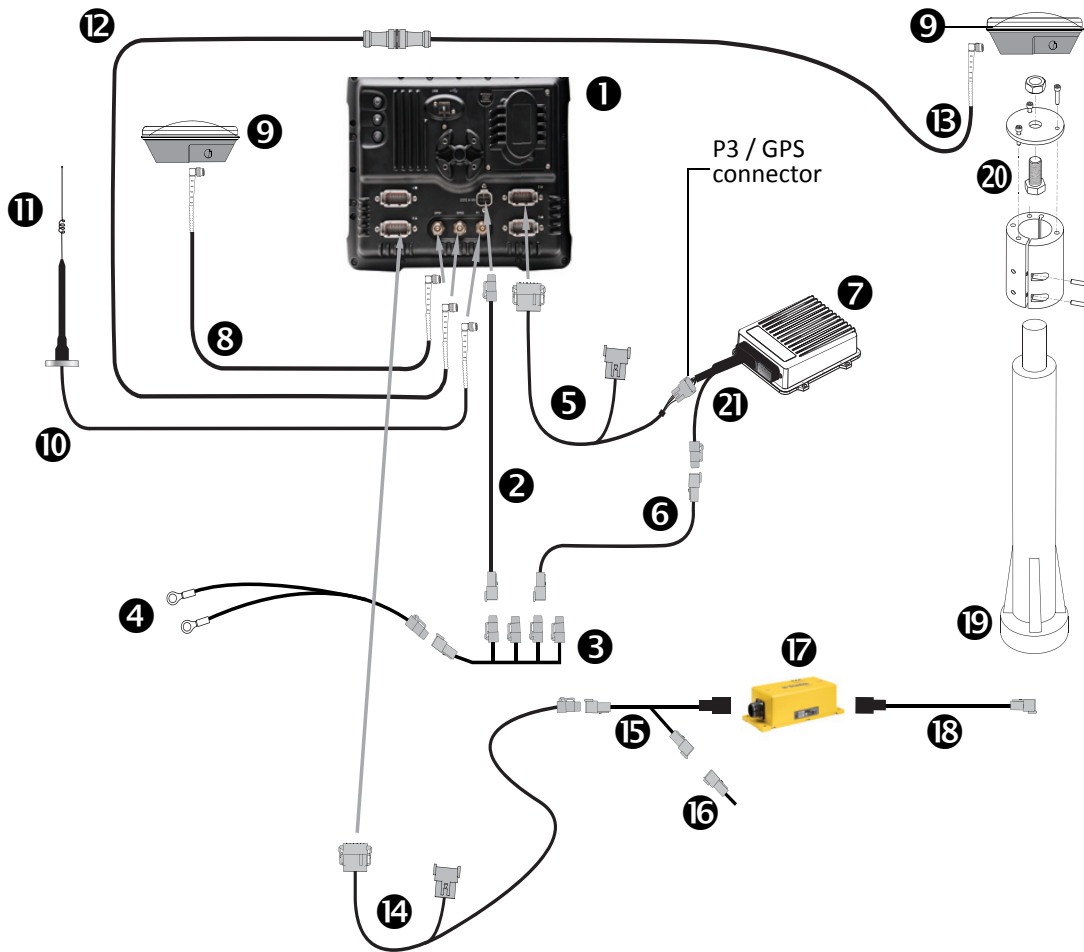

**CAUTION** – Connecting the Port Replicator on the FmX to NavController II cable 5 to the P4 or P12 connector of the NavController II harness 7 will result in damage to the FmX/FM-1000 integrated display, and will void the warranty.

Item	Description	Trimble part number
1	FmX integrated display	93100-02
2	FmX power cable	66694
3	FmX power cable with relay and switch (power bus)	67259
4	Basic power cable	67258
5	FmX to NavController II cable with port replicator	75741
6	2 pin DTM to 2 pin DT power adaptor	67095
7	NavController II	55563-00

Item	Description	Trimble part number
⑧	8 m GPS TNC/TNC RT angle cable	50449
⑨	Ag25 GNSS antenna (x2)	77038-00
⑩	NMO to TNC 20ft antenna cable and base	62120
⑪	900 MHz radio antenna kit	22882-10
⑫	Coaxial 160" N/f + TNC/m-ra cable	68295
⑬	Coaxial 480" N/m + TNC/m-ra cable	67472
⑭	FmX to CAN cable with port replicator	75407
⑮	CAN to VM and FieldLevel II cable	62039
⑯	CAN terminator	59783
⑰	Direct connect valve module, FRU	AG VM415
⑱	VM415 dual case direct cable	54376-100
⑲	Mast	MM2E-T
⑳	GPS mount	0367-3440
㉑	Main NavController II cable	54601

## FmX / Autopilot / FieldLevel II / John Deere direct-connect / RTK corrections

This figure shows how to connect the FmX integrated display with the Autopilot automated steering system, and the FieldLevel II system on John Deere direct-connect machines:

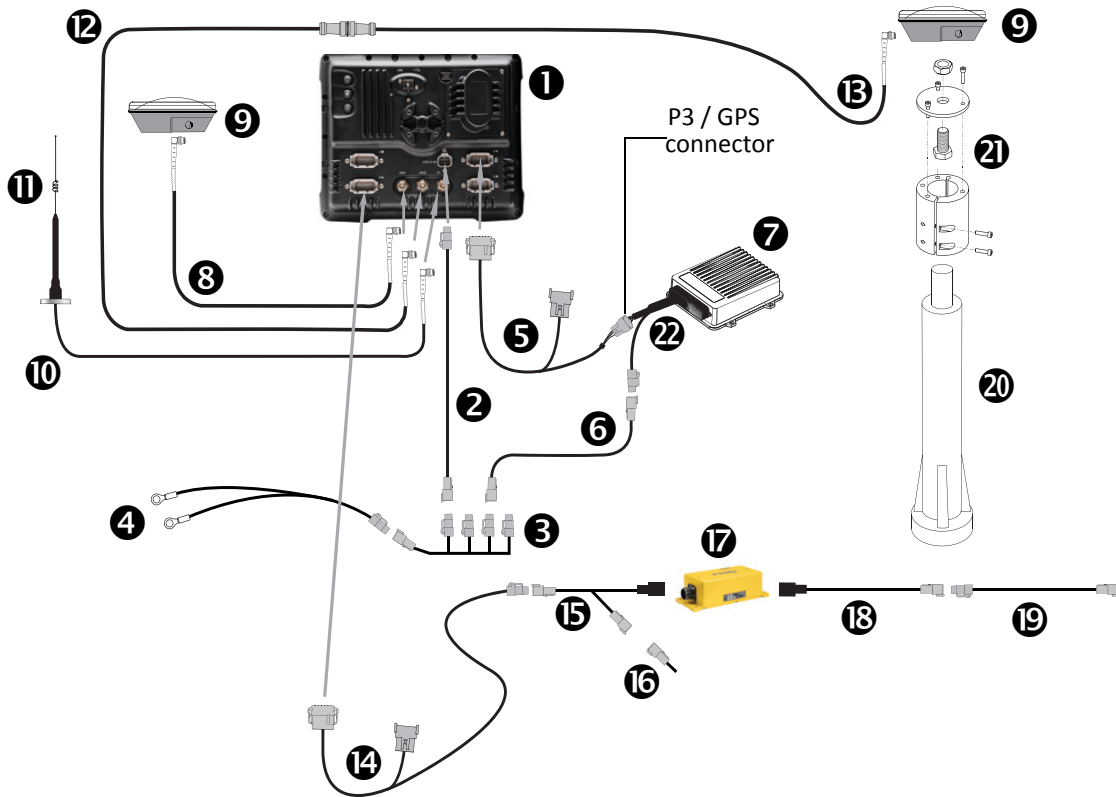

**CAUTION** – Connecting the Port Replicator on the FmX to NavController II cable 5 to the P4 or P12 connector of the NavController II harness 2 will result in damage to the FmX/FM-1000 integrated display, and will void the warranty.

Item	Description	Trimble part number
1	FmX integrated display	93100-02
2	FmX power cable	66694
3	FmX power cable with relay and switch (power bus)	67259
4	Basic power cable	67258
5	FmX to NavController II cable with port replicator	75741
6	2 pin DTM to 2 pin DT power adaptor	67095
7	NavController II	55563-00
8	8 m GPS TNC/TNC RT angle cable	50449
9	Ag25 GNSS antenna (x2)	77038-00
10	NMO to TNC 20ft antenna cable and base	62120
11	900 MHz radio antenna kit	22882-10

Item	Description	Trimble part number
12	Coaxial 160" N/f + TNC/m-ra cable	68295
13	Coaxial 480" N/m + TNC/m-ra cable	67472
14	FmX to CAN cable with port replicator	75407
15	CAN to VM and FieldLevel II cable	62039
16	CAN terminator	59783
17	Direct connect valve module	AG VM415
18	John Deere VM415 valve cable	AG 57765-070
19	John Deere wiring harness cable	AG 0793-1030-120
20	Mast	MM2E-T
21	GPS mount	0367-3440
22	Main NavController II cable	54601

## FmX / Autopilot / FieldLevel II / Proportional valve / RTK corrections

This figure shows how to connect the FmX integrated display with the Autopilot automated steering system, and the FieldLevel II system on proportional valve machines:

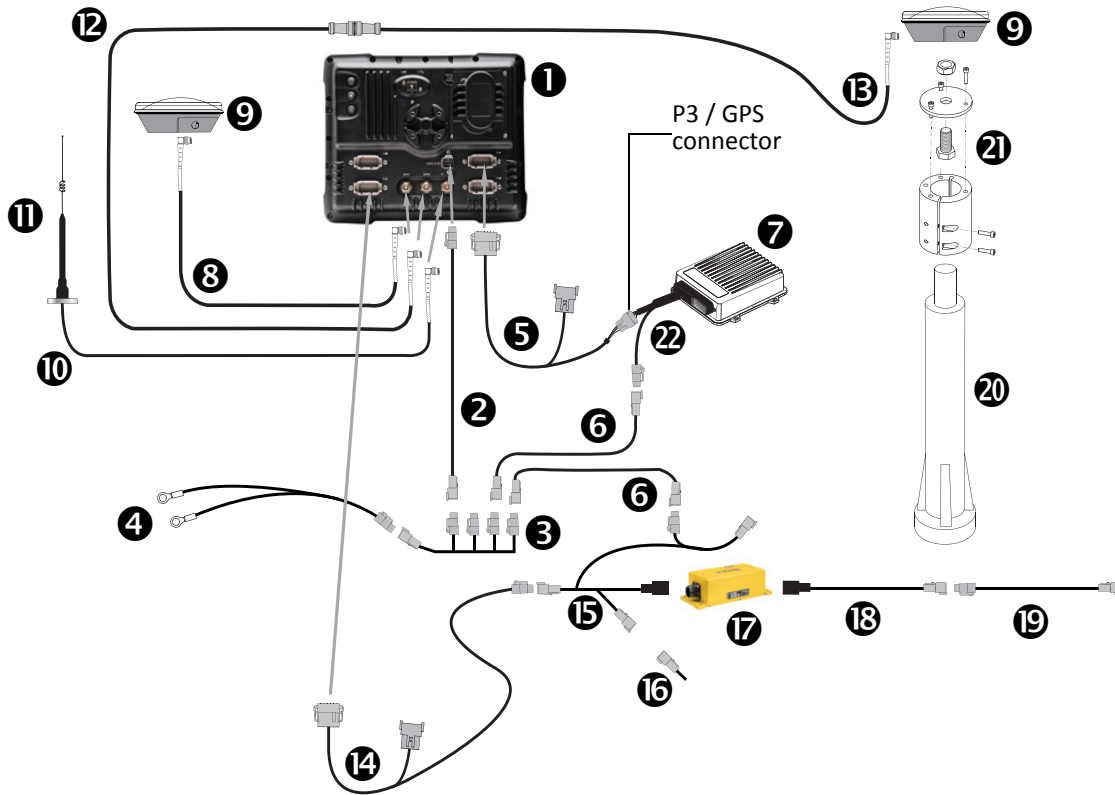

**CAUTION** – Connecting the Port Replicator on the FmX to NavController II cable ⑤ to the P4 or P12 connector of the NavController II harness ⑫ will result in damage to the FmX/FM-1000 integrated display, and will void the warranty.

Item	Description	Trimble part number
①	FmX integrated display	93100-02
②	FmX power cable	66694
③	FmX power cable with relay and switch (power bus)	67259
④	Basic power cable	67258
⑤	FmX to NavController II cable with port replicator	75741
⑥	2 pin DTM to 2 pin DT power adaptor	67095
⑦	NavController II	55563-00
⑧	8 m GPS TNC/TNC RT angle cable	50449
⑨	Ag25 GNSS antenna (x2)	77038-00
⑩	NMO to TNC 20ft antenna cable and base	62120
⑪	900 MHz radio antenna kit	22882-10

Item	Description	Trimble part number
12	Coaxial 160" N/f + TNC/m-ra cable	68295
13	Coaxial 480" N/m + TNC/m-ra cable	67472
14	FmX to CAN cable with port replicator	75407
15	FieldLevel II VM410/420 cable	62767
16	CAN terminator	59783
17	GCS400 valve module	AG VM410
18	GCS400 Dual Danfoss valve quick disconnect cable	58742-150
19	GCS300 SGL Danfoss valve quick disconnect cable	58729-200
20	Mast	MM2E-T
21	GPS mount	0367-3440
22	Main NavController II cable	54601

## FmX / Autopilot / FieldLevel II / PT valve / RTK corrections

This figure shows how to connect the FmX integrated display with the Autopilot automated steering system, and the FieldLevel II system on PT valve machines:

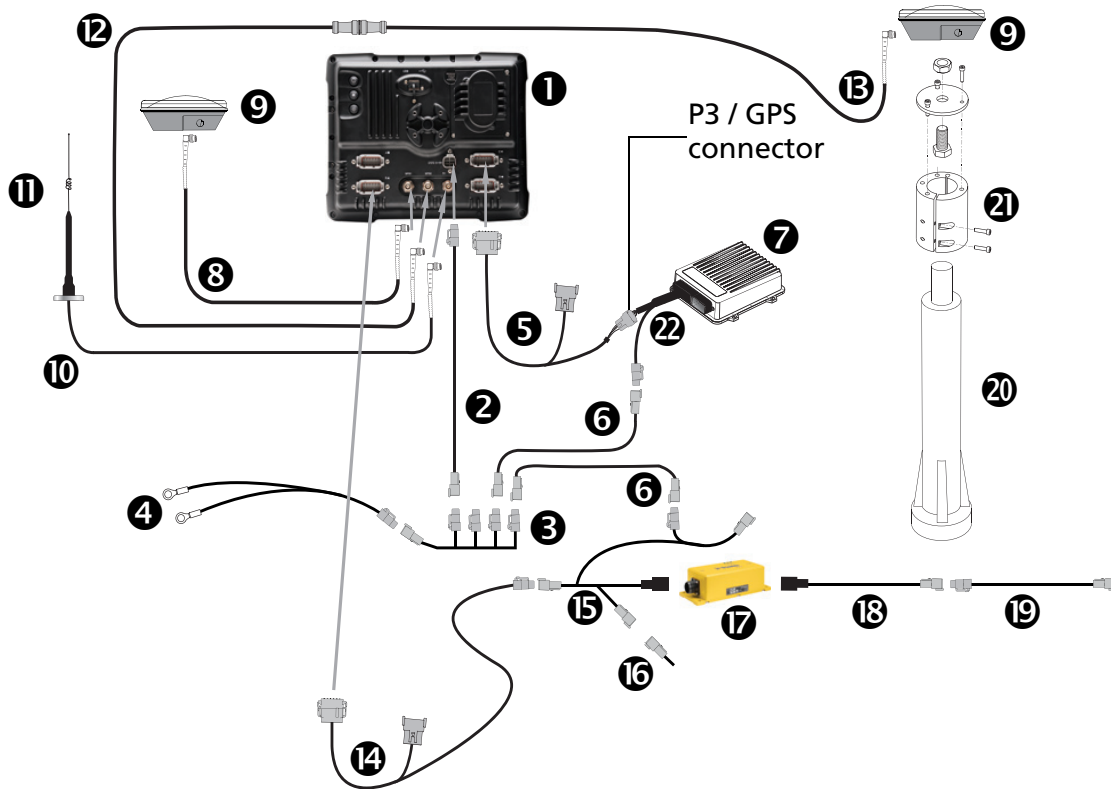

**CAUTION** – Connecting the Port Replicator on the FmX to NavController II cable 5 to the P4 or P12 connector of the NavController II harness 22 will result in damage to the FmX/FM-1000 integrated display, and will void the warranty.

Item	Description	Trimble part number
1	FmX integrated display	93100-02
2	FmX power cable	66694
3	FmX power cable with relay and switch (power bus)	67259
4	Basic power cable	67258
5	FmX to NavController II cable with port replicator	75741
6	2 pin DTM to 2 pin DT power adaptor	67095
7	NavController II	55563-00
8	8 m GPS TNC/TNC RT angle cable	50449
9	Ag25 GNSS antenna (x2)	77038-00
10	NMO to TNC 20ft antenna cable and base	62120
11	900 MHz radio antenna kit	22882-10

Item	Description	Trimble part number
12	Coaxial 160" N/f + TNC/m-ra cable	68295
13	Coaxial 480" N/m + TNC/m-ra cable	67472
14	FmX to CAN cable with port replicator	75407
15	FieldLevel II VM410/420 cable	62767
16	CAN terminator	59783
17	PWM valve module	AG VM420
18	GCS400 Dual PT valve quick disconnect cable	58932-150
19	GCS300 SGL PT valve quick disconnect cable	58947-200
20	Mast	MM2E-T
21	GPS mount	0367-3440
22	Main NavController II cable	54601

## FmX / FieldLevel II / Tandem or dual antenna / RTK corrections

This figure shows how to connect the FmX integrated display with tandem or dual antenna:

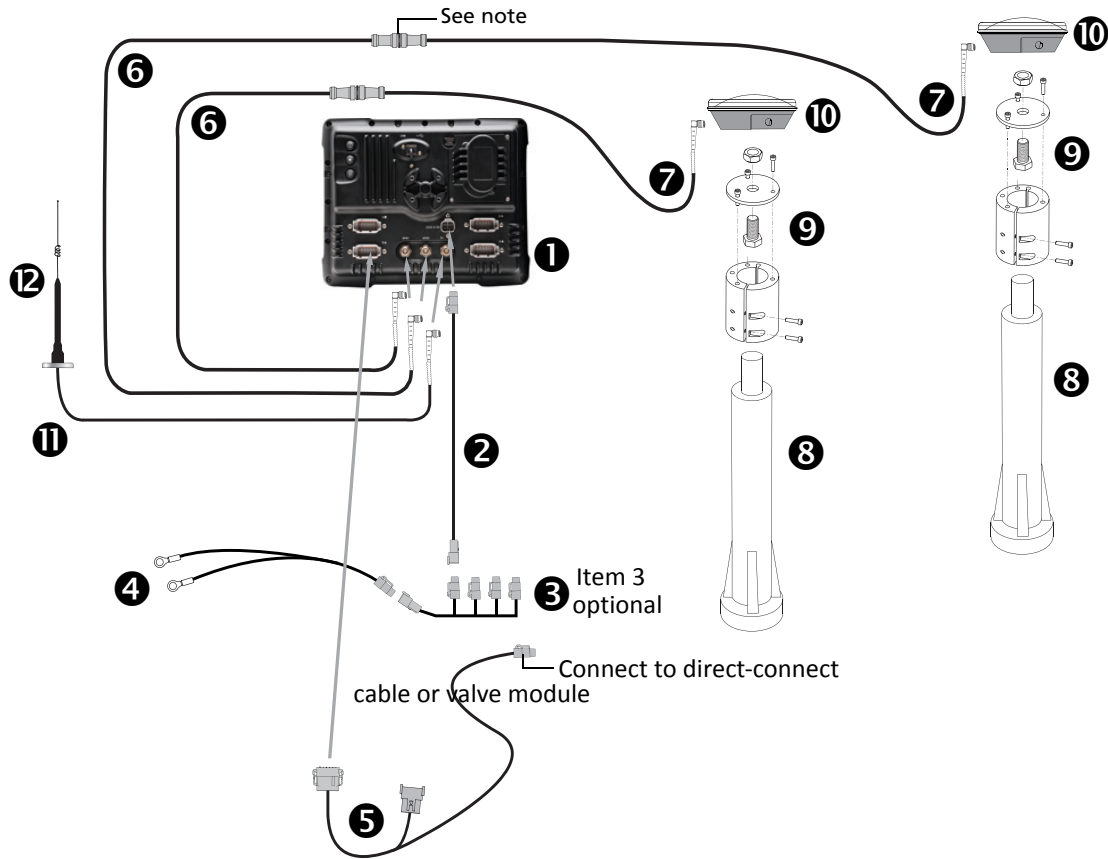

**Note** – An optional LMR400 65' extension cable (P/N 67473) is available for tandem buckets.

Item	Description	Trimble part number
1	FmX integrated display	93100-02
2	FmX power cable	66694
3	FmX power cable with relay and switch (power bus) - optional	67259
4	Basic power cable	67258
5	FmX to CAN cable with port replicator	75407
6	Coaxial 160" N/f + TNC/m-ra cable (x2)	68295
7	Coaxial 480" N/m + TNC/m-ra cable	67472
8	Mast (x2)	MM2E-T
9	GPS mount (x2)	0367-3440
10	Ag25 GNSS antenna (x2)	77038-00
11	NMO to TNC 20ft antenna cable and base	62120
12	900 MHz radio antenna kit	22882-10

# FmX / Autopilot / AgGPS 252/262 / FieldLevel II / Tandem or dual antenna / RTK corrections

This figure shows how to connect the FmX integrated display to the Autopilot system, an AgGPS 252/262 external receiver, with tandem or dual antenna:

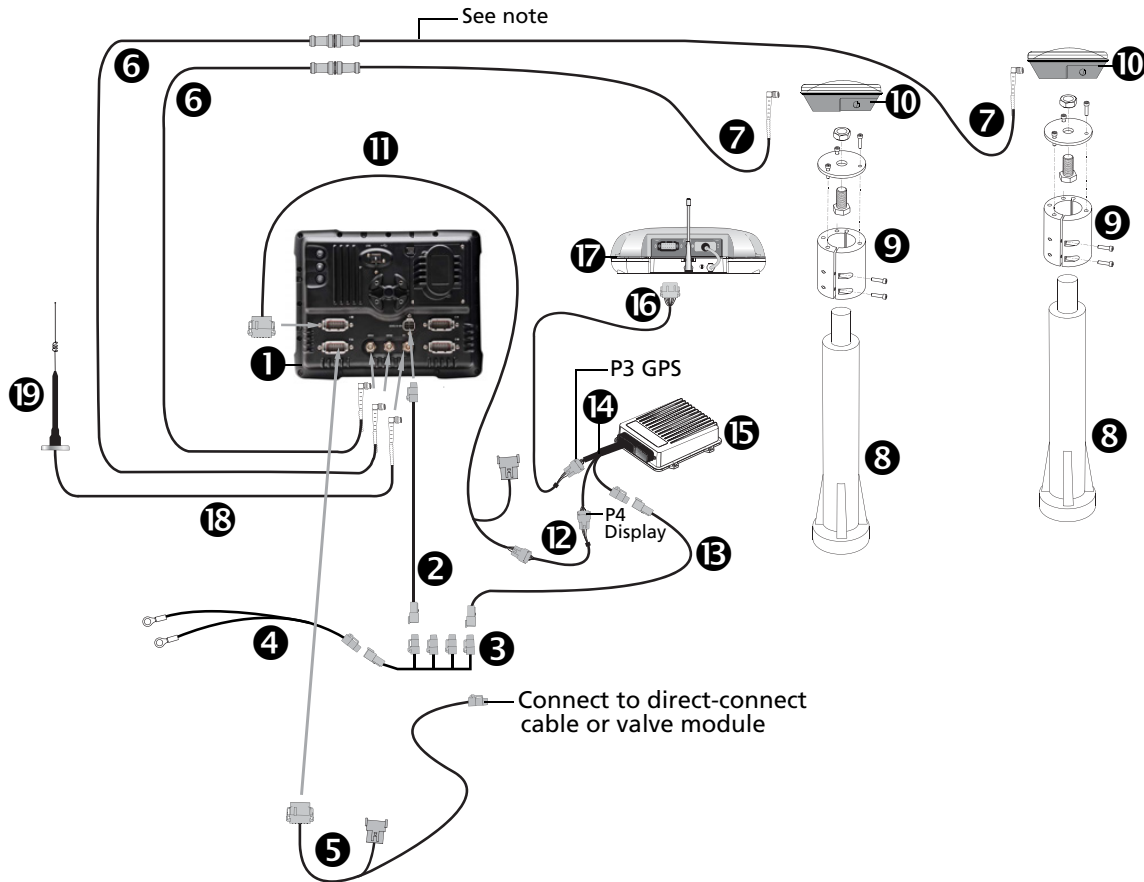

**CAUTION** – Connecting the Port Replicator on the FmX to NavController II cable 11 to the P4 or P12 connector of the NavController II harness 14 will result in damage to the FmX/FM-1000 integrated display, and will void the warranty.

**Note** – An optional LMR400 65' extension cable (P/N 67473) is available for tandem buckets.

Item	Description	Trimble part number
1	FmX integrated display	93100-02
2	FmX power cable	66694
3	FmX power cable with relay and switch (power bus) - optional	67259
4	Basic power cable	67258
5	FmX to CAN cable with port replicator	75407
6	Coaxial 160" N/f + TNC/m-ra cable (x2)	68295
7	Coaxial 480" N/m + TNC/m-ra cable	67472

Item	Description	Trimble part number
③	Mast (x2)	MM2E-T
⑨	GPS mount (x2)	0367-3440
⑩	Ag25 GNSS antenna (x2)	77038-00
⑪	FmX to NavController II cable with port replicator	75741
⑫	Cable assembly, 8-pin to 12-pin adaptor	76442
⑬	2 pin DTM to 2 pin DT power adaptor	67095
⑭	Main NavController II cable	54601
⑮	NavController II	55563-00
⑯	Cable, AgGPS 252/252 to NavController II	54608
⑰	AgGPS 252/262 receiver	55500-xx
⑱	NMO to TNC 20ft antenna cable and base	62120
⑲	900 MHz radio antenna kit	22882-10

## FmX / FieldLevel II / Without power bus

This figure shows how to connect the FmX integrated display with the FieldLevel II system without utilizing the power bus; several vehicle options are shown:

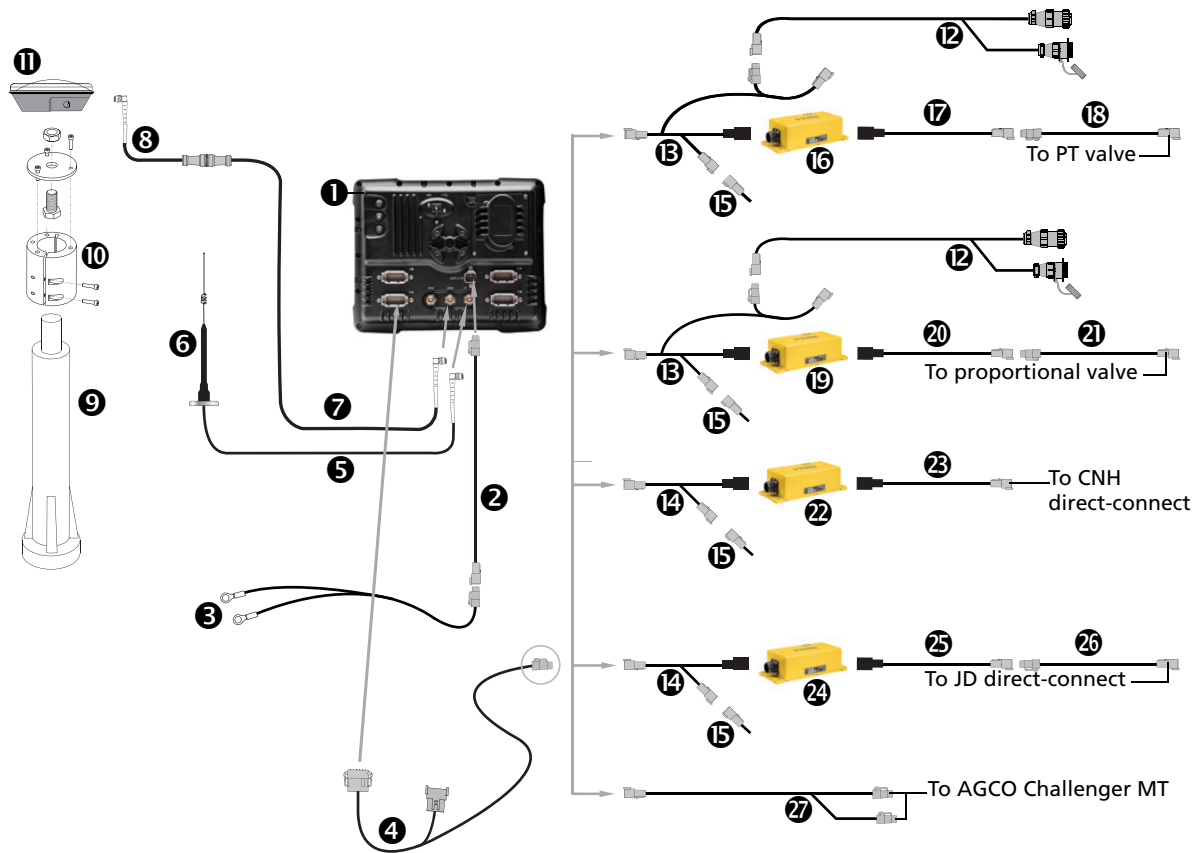

Item	Description	Trimble part number
1	FmX integrated display	93100-02
2	FmX power cable	66694
3	Basic power cable	67258
4	FmX to CAN cable with port replicator	75407
5	20' NMO to TNC antenna cable and base	62120
6	900 MHz radio antenna kit	22882-10
7	Coaxial 160" N/f + TNC/m-ra cable	68295
8	Coaxial 480" N/m + TNC/m-ra cable	67472
9	Mast	MM2E-T
10	GPS mount	0367-3440
11	Ag25 GNSS antenna	77038-00
12	Power cable	54630
13	FieldLevel II VM410 / 420 cable	62767
14	FieldLevel II CAN to VM cable	62039
15	CAN terminator	59783

Item	Description	Trimble part number
16	PWM valve module	AG VM420
17	GCS400 Dual PT valve quick disconnect cable	58932-150
18	GCS300 SGL PT valve quick disconnect cable	58947-200
19	GCS400 valve module	AG VM410
20	GCS400 Dual Danfoss valve quick disconnect cable	58742-150
21	GCS300 SGL Danfoss valve quick disconnect cable	58729-200
22	FRU direct connect valve module	AG VM415
23	VM415 dual case direct cable	54376-100
24	FRU direct connect valve module	AG VM415
25	John Deere VM415 valve cable	AG 57765-070
26	John Deere wiring harness cable	AG 0793-1030-120
27	Challenger MT CAN interface to Autopilot system cable	62108

# Connecting to an ISOBus System

## In this chapter:

- [FmX / ISOBus](#)

This chapter shows how to connect the FmX integrated display to an ISOBus system.



---

**CAUTION** – Connecting the Port Replicator on the FmX display to the NavController II cable to the P4 or P12 connector of the NavController II harness will result in damage to the FmX / FM-1000 integrated display, and will void the warranty.

---

## FmX / ISOBus

This figure shows how to connect the FmX integrated display an ISOBus system:

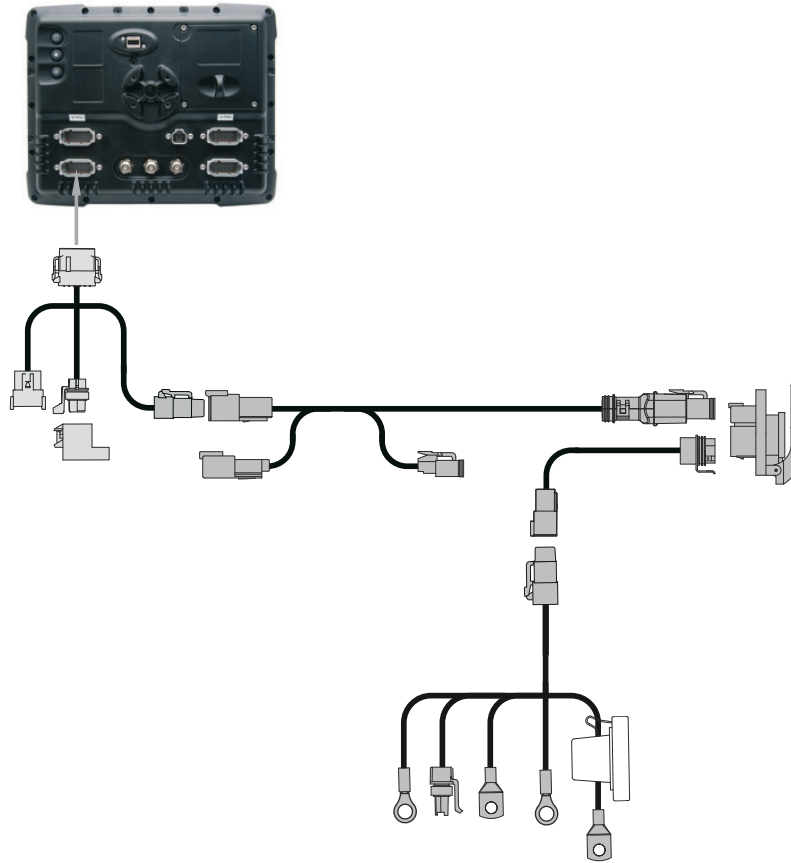

**CAUTION** – Connecting the Port Replicator on the FmX to NavController II cable ⑤ to the P4 or P12 connector of the NavController II harness ⑬ will result in damage to the FmX/FM-1000 integrated display, and will void the warranty.

Item	Description	Trimble part number
①	FmX integrated display	93100-02
②	FmX power cable	66694
③	FmX power cable with relay and switch (power bus)	67259
④	Basic power cable	67258
⑤	FmX to NavController II cable with port replicator	75741
⑥	2 pin DTM to 2 pin DT power adaptor	67095
⑦	NavController II	55563-00
⑧	8 m GPS TNC/TNC RT angle cable	50449
⑨	Ag25 GNSS antenna	77038-00
⑩	NMO to TNC 20ft antenna cable and base	62120
⑪	900 MHz radio antenna kit	22882-10

Item	Description	Trimble part number
12	Coaxial 160" N/f + TNC/m-ra cable	68295
13	Coaxial 480" N/m + TNC/m-ra cable	67472
14	FmX to CAN cable with port replicator	75407
15	Challenger MT CAN interface - FieldLevel II	62108
16	Mast	MM2E-T
17	GPS mount	0367-3440
18	Main NavController II cable	54601
19	Auxiliary NavController II cable	54602
20	Challenger MT CAN interface to Autopilot cable	56850

# Installing Accessories

## In this chapter:

- FmX / 4 AgCam cameras / Autopilot / RTK corrections
- FmX / Autopilot / EZ-Boom / Display-mounted LB25 external lightbar (option 1)
- FmX / Autopilot / EZ-Boom / Remote-mounted LB25 external lightbar (option 2)
- FmX / Autopilot / EZ-Boom / multiple LB25 external lightbars / RTK corrections
- FmX / EZ-Remote joystick

This chapter shows the different accessories, including lightbars and cameras, that can be added to the FmX integrated display.



---

**CAUTION** – Connecting the Port Replicator on the FmX display to the NavController II cable to the P4 or P12 connector of the NavController II harness will result in damage to the FmX / FM-1000 integrated display, and will void the warranty.

---

## FmX / 4 AgCam cameras / Autopilot / RTK corrections

This figure shows how to connect the FmX integrated display with the Autopilot automated steering system and 4 AgCam cameras, while using RTK corrections:

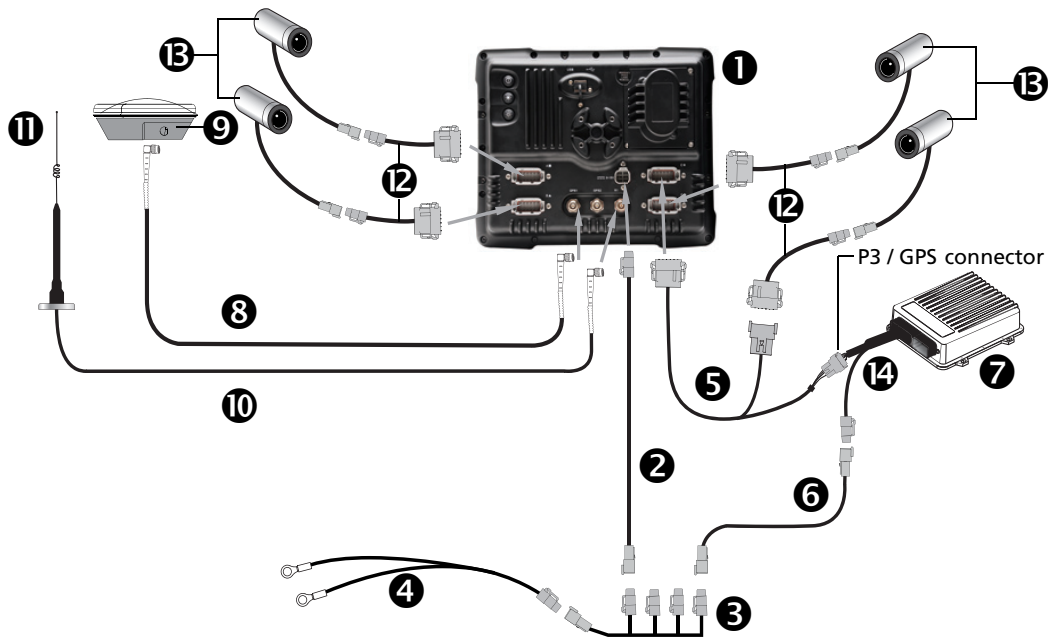

**CAUTION** – Connecting the Port Replicator on the FmX to NavController II cable ⑤ to the P4 or P12 connector of the NavController II harness ⑭ will result in damage to the FmX/FM-1000 integrated display, and will void the warranty.

Item	Description	Trimble part number
①	FmX integrated display	93100-02
②	FmX power cable	66694
③	FmX power cable with relay and switch (power bus)	67259
④	Basic power cable	67258
⑤	FmX to NavController II cable with port replicator	75741
⑥	2 pin DTM to 2 pin DT power adaptor	67095
⑦	NavController II	55563-00
⑧	8 m GPS TNC/TNC RT angle cable	50449
⑨	Ag25 GNSS antenna	77038-00
⑩	NMO to TNC 20ft antenna cable and base	62120
⑪	900 MHz radio antenna kit	22882-10
⑫	FmX to AgCam cable	77401
⑬	FmX AgCam stainless steel camera kit (up to 4 units) FmX AgCam aluminium camera kit (up to 4 units)	77400-10 77400-20
⑭	Main NavController II cable	54601

## FmX / Autopilot / EZ-Boom / Display-mounted LB25 external lightbar (option 1)

This figure shows how to connect the FmX integrated display with the Autopilot automated steering system, the EZ-Boom automated application control system, and the display-mounted LB25 external lightbar with RTK corrections:

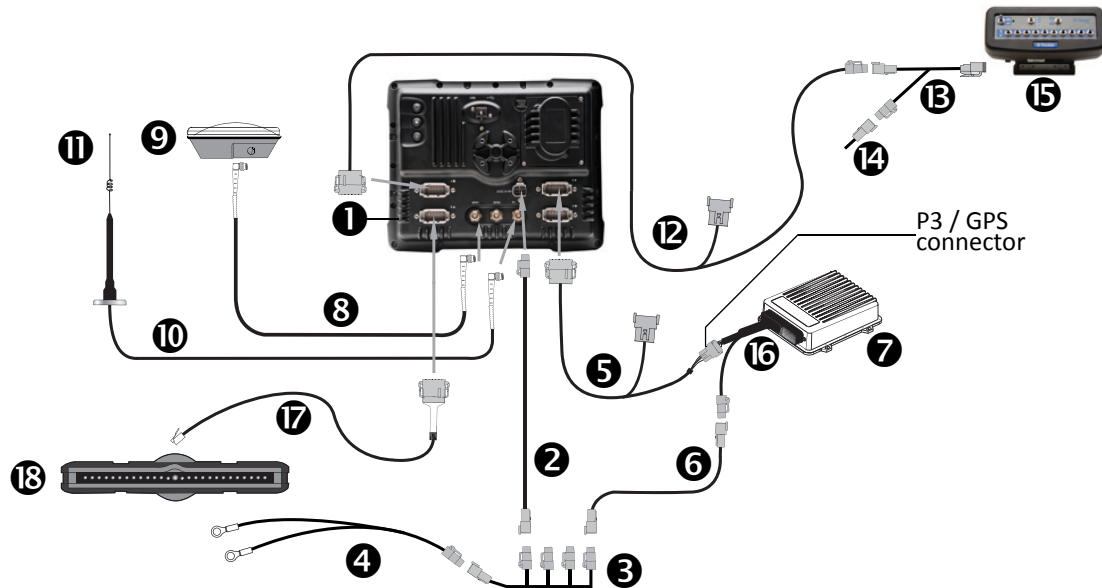

**CAUTION** – Connecting the Port Replicator on the FmX to NavController II cable ⑤ to the P4 or P12 connector of the NavController II harness ⑬ will result in damage to the FmX/FM-1000 integrated display, and will void the warranty.

*Note* – When using the LB25 external lightbar, no other CAN device may be used on the port.

*Note* – When using the LB25 external lightbar and cable P/N 72420, use only port B with internal termination.

Item	Description	Trimble part number
①	FmX integrated display	93100-02
②	FmX power cable	66694
③	FmX power cable with relay and switch (power bus)	67259
④	Basic power cable	67258
⑤	FmX to NavController II cable with port replicator	75741
⑥	2 pin DTM to 2 pin DT power adaptor	67095
⑦	NavController II	55563-00
⑧	8 m GPS TNC/TNC RT angle cable	50449
⑨	Ag25 GNSS antenna	77038-00
⑩	NMO to TNC 20ft antenna cable and base	62120

Item	Description	Trimble part number
①	900 MHz radio antenna kit	22882-10
②	FmX to CAN cable with port replicator	75407
③	EZ-Boom 2010 to FMD and EZ-Guide 500 cable	61437
④	CAN terminator	59783
⑤	EZ-Boom controller	59898-00
⑥	Main NavController II cable	54601
⑦	FmX to LB25, 12-pin to RJ-pin	72420
⑧	LB25 external lightbar	82400-xx

## FmX / Autopilot / EZ-Boom / Remote-mounted LB25 external lightbar (option 2)

This figure shows how to connect the FmX integrated display with the Autopilot automated steering system, the EZ-Boom automated application control system, and the remotely-mounted LB25 external lightbar while using RTK corrections:

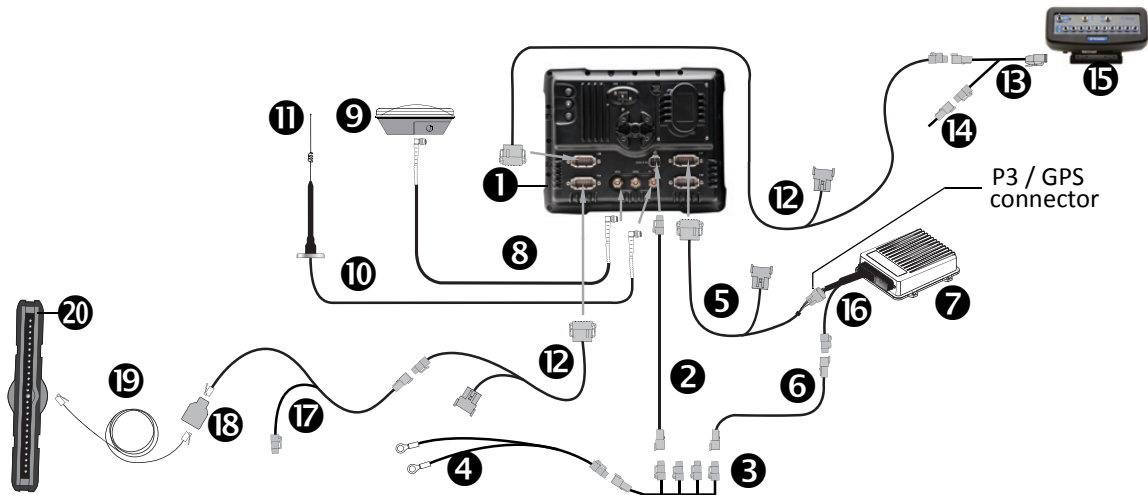

**CAUTION** – Connecting the Port Replicator on the FmX to NavController II cable ⑤ to the P4 or P12 connector of the NavController II harness ⑬ will result in damage to the FmX/FM-1000 integrated display, and will void the warranty.

*Note* – When using the LB25 external lightbar, no other CAN device may be used on the port.

*Note* – When using the LB25 external lightbar and cable P/N 67094, use only port B with internal termination.

Item	Description	Trimble part number
①	FmX integrated display	93100-02
②	FmX power cable	66694
③	FmX power cable with relay and switch (power bus)	67259
④	Basic power cable	67258
⑤	FmX to NavController II cable with port replicator	75741
⑥	2 pin DTM to 2 pin DT power adaptor	67095
⑦	NavController II	55563-00
⑧	8 m GPS TNC/TNC RT angle cable	50449
⑨	Ag25 GNSS antenna	77038-00
⑩	NMO to TNC 20ft antenna cable and base	62120
⑪	900 MHz radio antenna kit	22882-10

Item	Description	Trimble part number
12	FmX to CAN cable with port replicator	75407
13	EZ-Boom 2010 to FMD and EZ-Guide 500 cable	61437
14	CAN terminator	59783
15	EZ-Boom controller	59898-00
16	Main NavController II cable	54601
17	FmX to LB25 remote lightbar cable	67094
18	Splitter cable, RJII F to 2x RJII F	72422
19	7' extension cable (optional)	69781
20	LB25 external lightbar	82400-xx

## FmX / Autopilot / EZ-Boom / multiple LB25 external lightbars / RTK corrections

This figure shows how to connect the FmX integrated display with the Autopilot automated steering system, the EZ-Boom automated application control system, and multiple LB25 external lightbar, while using RTK corrections:

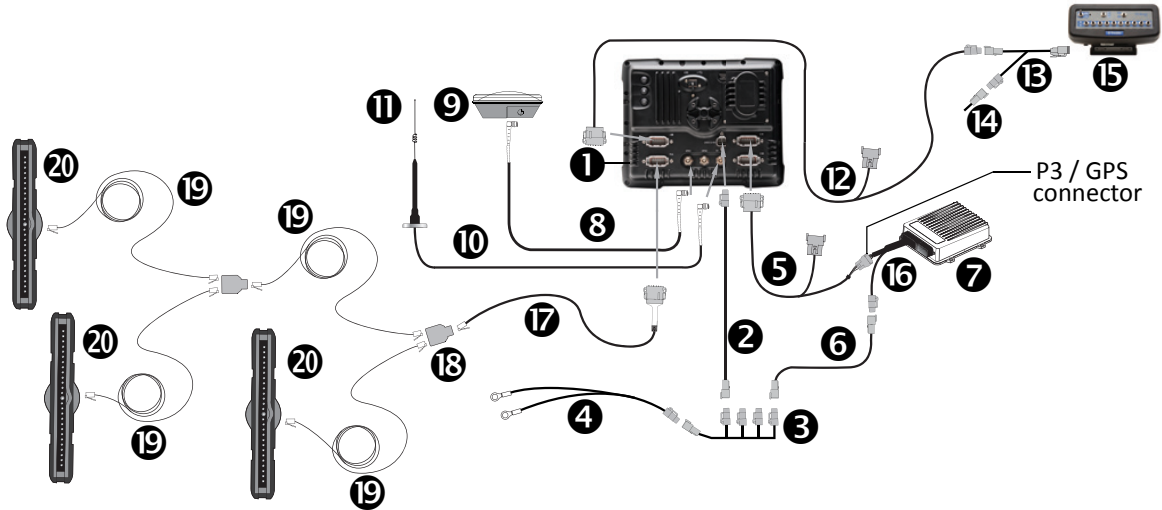

**CAUTION** – Connecting the Port Replicator on the FmX to NavController II cable **5** to the P4 or P12 connector of the NavController II harness **16** will result in damage to the FmX/FM-1000 integrated display, and will void the warranty.

*Note* – When using the LB25 external lightbars, no other CAN device may be used on the port.

*Note* – When using the LB25 external lightbar and cable P/N 72420, use only port B with internal termination.

Item	Description	Trimble part number
1	FmX integrated display	93100-02
2	FmX power cable	66694
3	FmX power cable with relay and switch (power bus)	67259
4	Basic power cable	67258
5	FmX to NavController II cable with port replicator	75741
6	2 pin DTM to 2 pin DT power adaptor	67095
7	NavController II	55563-00
8	8 m GPS TNC/TNC RT angle cable	50449
9	Ag25 GNSS antenna	77038-00
10	NMO to TNC 20ft antenna cable and base	62120
11	900 MHz radio antenna kit	22882-10
12	FmX to CAN cable with port replicator	75407

Item	Description	Trimble part number
13	EZ-Boom 2010 to FMD and EZ-Guide 500 cable	61437
14	CAN terminator	59783
15	EZ-Boom controller	59898-00
16	Main NavController II cable	54601
17	FmX to LB25 cable, 12-pin to RJ-pin	72420
18	Splitter, RJII F to 2x RJII F	72422
19	7' extension cables	69781
20	LB25 external lightbars	82400-xx

## FmX / EZ-Remote joystick

Connecting the FmX integrated display to the EZ-Remote joystick:

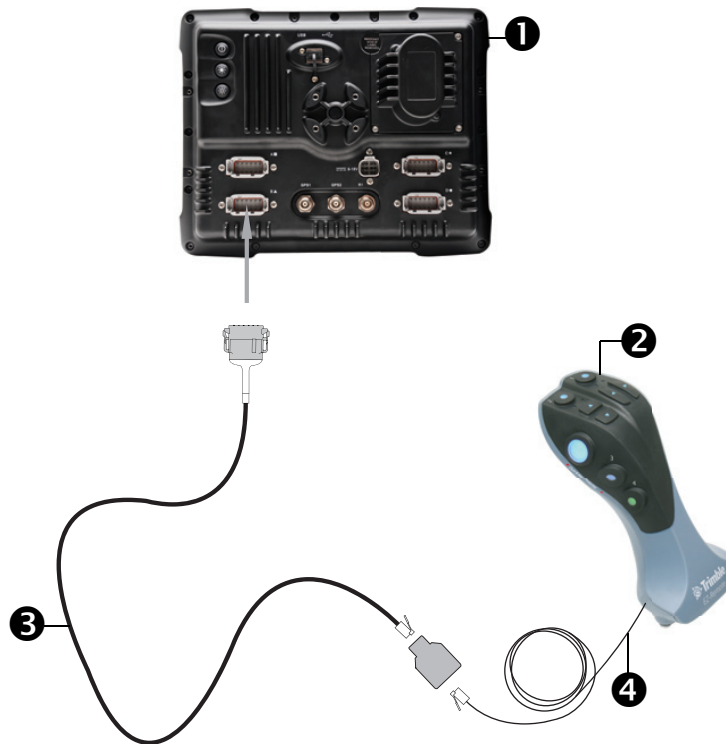

Item	Description	Trimble part number
1	FmX integrated display	93100-01
2	EZ-Remote joystick	83200-00
3	FmX to CAN cable	72420
4	Splitter, RJ11 F to 2x RJ11 F	72422